

BenQ

PB2140 / PB2240 Digital Projector

Mobile Series

User's Manual

Welcome

Copyright

Copyright 2005 by BenQ Corporation. All rights reserved. No part of this publication may be reproduced, transmitted, transcribed, stored in a retrieval system or translated into any language or computer language, in any form or by any means, electronic, mechanical, magnetic, optical, chemical, manual or otherwise, without the prior written permission of this company.

Disclaimer

BenQ Corporation makes no representations or warranties, either expressed or implied, with respect to the contents hereof and specifically disclaims any warranties, merchantability or fitness for any particular purpose. Further, BenQ Corporation reserves the right to revise this publication and to make changes from time to time in the contents hereof without obligation of this company to notify any person of such revision or changes.

*DLP, Digital Micromirror Device and DMD are trademarks of Texas Instruments. Others are copyrights of their respective companies or organizations.

Table of Contents

Important Safety Instructions	1
Introduction	5
Projector Features	5
Shipping Contents	6
Optional Accessories	7
Projector Exterior View	7
Front / Upper Side	7
Rear Side	7
Bottom Side	7
Controls and Functions	8
External Control Panel	8
Remote Control Description	9
Remote Control Effective Range	10
Installing or Replacing the Battery	10
Connection	11
Connecting to a Laptop or Desktop Computer	11
Connecting Equipment to the Component Video Input	12
Connecting Video and S-Video Devices	12
Installation.....	14
Choosing a Location	14
Adjusting the Height	15
Screen Size	15
Operation	17
Start Up	17
Shutdown	18
Digital Keystone Correction	19
Source Selection	20
Auto Adjustment	20
Blank	21
Zoom / Focusing	21
Menu Operation	22
Menu System	22
Using the Menus	23
1. Picture Menu	24

2. Pro-Picture Menu	26
3. Setting Menu	27
4. Advance Menu	28
5. Information Menu	30
Maintenance	31
Cleaning the Lens	31
Cleaning the Projector Case	31
Storing the Projector	31
Transporting the projector	31
Lamp Information	32
Warning Message	32
Replacing the Lamp	32
Temp Information	34
Indicators	34
Service Information	36
Accessories (included in the standard package)	36
Optional Accessories (not included in the standard package)	36
Ordering Parts or Getting Information	36
Troubleshooting	37
Specifications	38
Projector Specifications	38
Dimensions	39
Timing Chart	40
Supported Timing for PC Input	40
Supported Timing for Component-YPbPr Input	40
Supported Timing for Video and S-Video Inputs	40
Warranty	41
Limited Warranty	41
Regulation Statements	42
FCC Statement	42
EEC Statement	42
MIC Statement	42

1 Important Safety Instructions

Your BenQ projector is designed and tested to meet the latest standards for safety of information technology equipment. However, to ensure safe use of this product, it is important that you follow the instructions mentioned in this manual and marked on the product.

Caution

- **To prevent shock, do not open the cabinet.** There are no user serviceable parts inside.

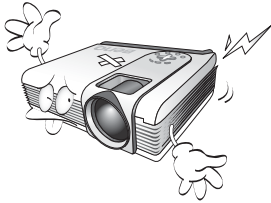

- **Please read this user's manual before you operate your projector.** Save this user's manual for future reference.

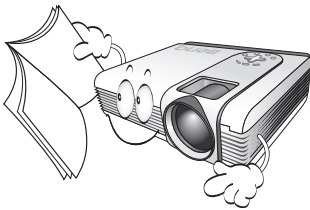

- **Do not look straight at the projector lens during operation.** The intense light beam may damage your eyes.

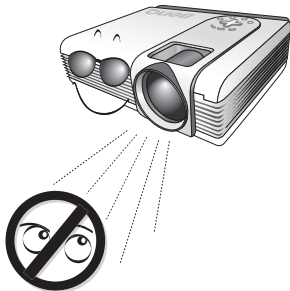

- **Refer servicing to qualified service personnel.**

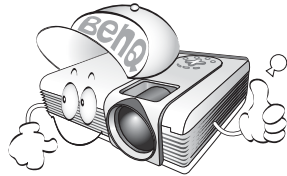

- **Always open the lens shutter or remove the lens cap when the projector lamp is on.**



- In some countries, the line voltage is NOT stable. This projector is designed to operate safely within a mains voltage between 100 to 240 volts AC, but could fail if power cuts or surges of ± 10 volts occur. **In areas where the mains voltage may fluctuate or cut out, it is recommended that you connect your projector through a power stabilizer, surge protector or uninterruptible power supply (UPS).**

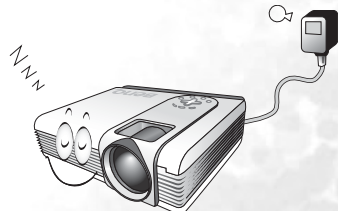

Safety Instructions

1. The lamp becomes extremely hot during operation. Allow the projector to cool for approximately 45 minutes prior to removing the lamp assembly for replacement.

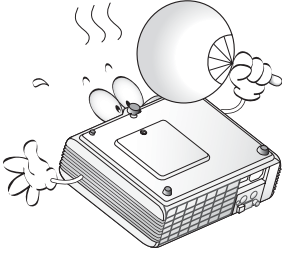

2. Do not operate lamps beyond the rated lamp life. Excessive operation of lamps beyond the rated life could cause them to break on rare occasions.

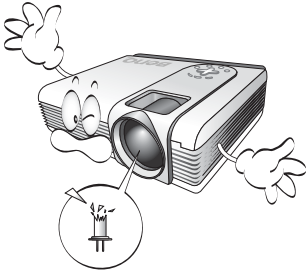

3. Never replace the lamp assembly or any electronic components unless the projector is unplugged.

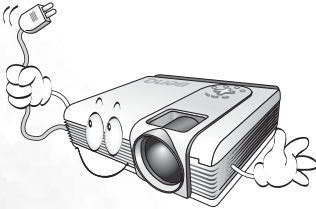

4. Do not place this product on an unstable cart, stand, or table. The product may fall, sustaining serious damage.

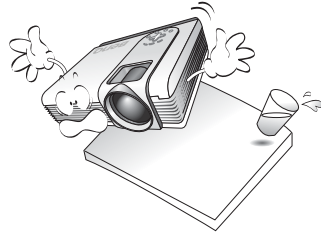

5. To reduce the risk of electric shock, do not disassemble this appliance. Take it to a qualified technician when service or repair is required. Incorrect reassembly can cause malfunction of the projector or electric shock when the appliance is subsequently used.

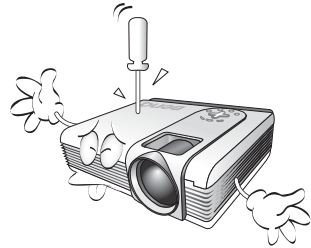

6. This product is capable of displaying inverted images for ceiling mount installation. Please use BenQ's Ceiling Mounting Kit for mounting the unit and ensure it is securely installed.

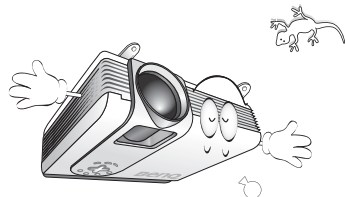

Safety Instructions (Continued)

7. Do not place this projector in any of the following environments.

- Space that is poorly ventilated or confined. Allow at least 50 cm clearance from walls and free flow of air around the projector.
- Locations where temperatures may become excessively high, such as the inside of a car with all windows rolled up.
- Locations where excessive humidity, dust, or cigarette smoke may contaminate optical components, shortening the projector's life span and darkening the image.



- Locations near fire alarms
- Locations with an ambient temperature above 40°C / 104°F
- Locations where the altitudes are higher than 10000 feet.

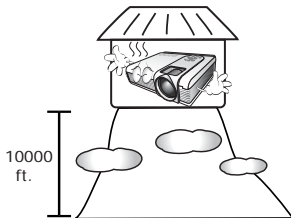

8. Do not block the ventilation holes.

- Do not place this unit on a blanket, bedding or any other soft surface.
- Do not cover this unit with a cloth or any other item.
- Do not place inflammables near the projector.



If the ventilation holes are seriously obstructed, overheating inside the unit may result in a fire.

9. Always place the unit on a level, horizontal surface during operation.

- Do not use if tilted at an angle of more than 10 degrees left to right, nor at angle of more than 15 degrees front to back. Using the unit when it is not fully horizontal may cause a malfunction of, or damage to, the lamp.

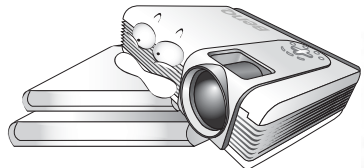

10. Do not stand the unit on end vertically.

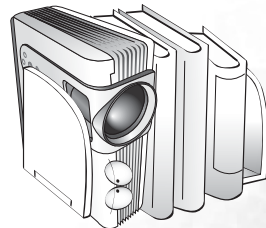

Doing so may cause the unit to fall over, causing injury or resulting in damage to the unit.

Safety Instructions (Continued)

11. Do not step on the projector or place any objects upon it.



Besides probable physical damage to the projector, doing so may result in accidents and possible injury.

12. Do not block the projection lens with any objects when the projector is under operation as this could cause the objects to become heated or deformed or even cause a fire. To temporarily turn off the lamp, press **Blank** on the projector or remote control.

13. Do not place liquids near or on the projector. Liquids spilled into the projector may cause it to fail. If the projector does become wet, disconnect it from the power supply's wall socket and call BenQ to have the projector serviced.



2 Introduction

Projector Features

The projector integrates high-performance optical engine projection and a user-friendly design to deliver high reliability and ease of use.

The projector offers the following features:

- Compact and portable unit
- High quality manual zoom lens
- One-key auto-adjustment to display the best picture quality
- Digital keystone correction to correct distorted images
- Adjustable color balance control for data/video display
- Ultra-high brightness projection lamp
- Ability to display 16.7 million colors
- On-screen menus in 10 languages: English, French, German, Italian, Spanish, Russian, Traditional Chinese, Simplified Chinese, Japanese and Korean.
- Switchable normal and Economic modes to reduce the power consumption
- Powerful AV function to provide high quality AV picture
- HDTV compatibility (YPbPr)

 **Note: The brightness of the projected image will vary depending on the ambient lighting conditions and contrast/brightness settings.**

 **The lamp brightness will decline over time and may vary within the lamp manufacturers specifications. This is normal and expected behavior.**

Shipping Contents

The projector is shipped with the cables required for connection to a PC and to video equipment. Carefully unpack and verify that you have all of the items shown below. If any of these items are missing, please contact your place of purchase.



Projector

Soft Carry Case

Remote Control

User's Manual



Batteries

3-2 Power Converter

User's Manual CD

Quick Start Guide

Warranty Booklet



USB Cable

S-Video Cable

Video Cable

VGA Cable

Audio Cable



US



EU



UK

Power Cord 110V

Power Cord 220V

Power Cord 240V

 Pull the tab before using the remote control.



Optional Accessories

1. Macintosh adapter
2. 200W lamp module
3. Ceiling mount kit
4. Wireless Pro
5. Presentation Plus
6. Component Video cable

Projector Exterior View

Front / Upper Side

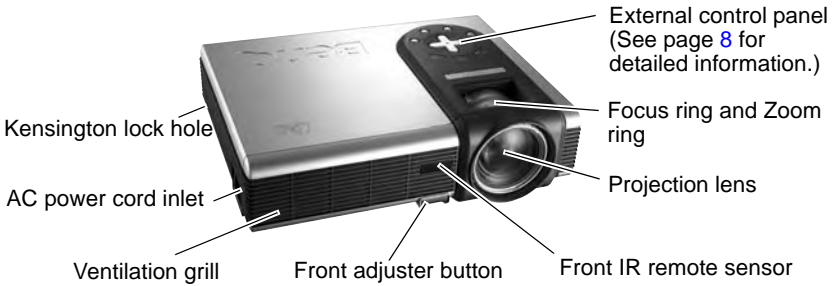

Rear Side

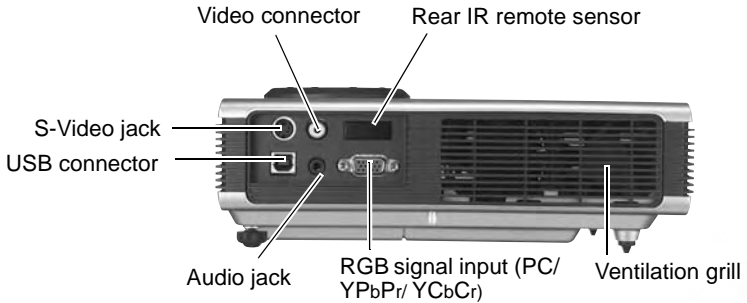

Bottom Side

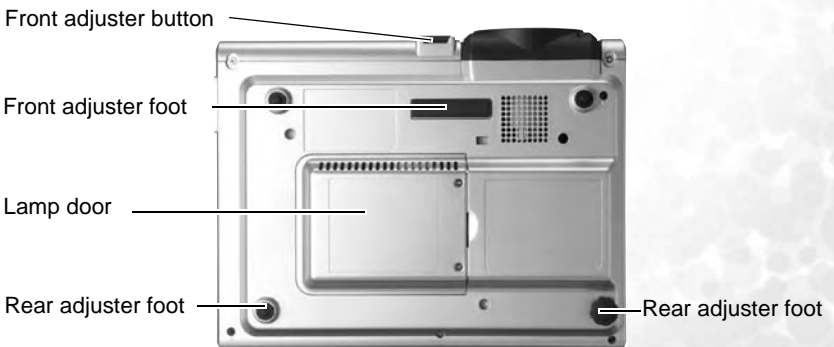

Controls and Functions

External Control Panel

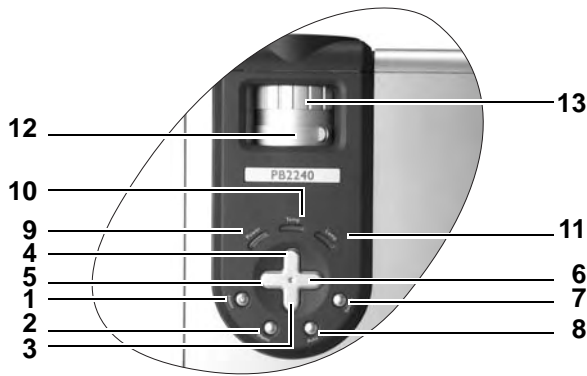

- 1. Power (Refer to pages 17 and 18 for more information.)**
Turns the projector on or off.
- 2. Menu**
Opens, saves and exits the on-screen menu.
- 3. Down ▾**
- 4. ^ Up**
- 5. ‹ Left**
- 6. Right ▶**
The #2 to #6 keys are used to select the desired menu items and to make adjustments. **Refer to page 23 for more information.**
When the on-screen menu is not activated, the ‹ **Left** and **Right** ▶ keys function as **Keystone -/+** hot keys. **Refer to page 19 for more information.**
- 7. Source (Refer to page 20 for information.)**
Sequentially selects the input signal Analog RGB, Video or S-Video.
- 8. Auto (Refer to page 20 for more information.)**
Automatically determines the best picture settings for the displayed image.
- 9. Power indicator light (Refer to page 34 for more information.)**
Lights up or flashes when the projector is under operation.
- 10. Temperature warning light (Refer to page 34 for more information.)**
Flashes red if the projector's temperature becomes too high.
- 11. Lamp indicator light (Refer to page 34 for more information.)**
Indicates the status of the lamp. Lights up or flashes when the lamp has developed a problem.
- 12. Zoom ring**
Adjusts the size of the image. Rotate clockwise to enlarge the image or rotate counter-clockwise to make the image smaller.
- 13. Focus ring**
Adjusts the focus of the projected image.

Remote Control Description

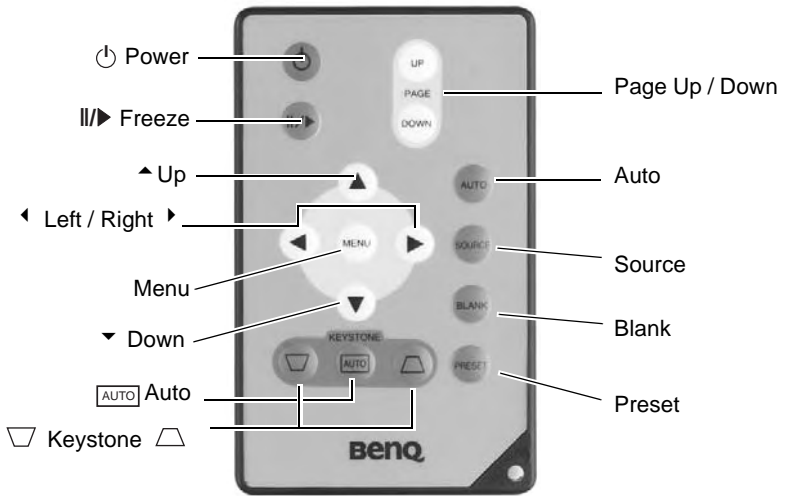

Functions	Descriptions
Power	Turns the projector on or off. Refer to pages 17 and 18 for more information.
Freeze	The image is frozen when Freeze is pressed. A "Pause" icon will appear in the lower right corner of the screen. To release the function, press Freeze again.
▲ Up, Menu ◀ Left / Right ▶, ▼ Down	Used to select the desired menu items and to make adjustments. Refer to page 23 for more information.
Auto keystone	Automatically corrects trapezoidal distortion resulting from the angle of projection. Refer to page 19 for more information.
Keystone	Manually corrects distorted images resulting from the angles of projection. Refer to page 19 for more information.
Page Up and Down	Connect the projector to your PC or notebook with a USB cable prior to using this function. You can operate your Power Point presentation moving forwards and backwards by pressing Page Up and Page Down.
Auto	Automatically determines the best picture settings for displayed image. Refer to page 20 for more information.
Source	Sequentially select the input signal RGB, Component Video, S-Video or Video. Refer to page 20 for information.

Blank	In order to draw the audience's full attention to the presenter, you can use Blank to hide the screen image. Press Blank again to restore the image. Refer to page 21 for more information.
Preset	According to the selected input signal, there are several picture setup options available: Vivid mode, Presentation mode, Gaming mode, Video mode, Cinema mode and Economic mode. Refer to page 24 for more information.

Remote Control Effective Range

Infra Red (IR) remote control sensors are located on the front and the back of the projector. The remote control must be held at an angle within 30 degrees of the projector's IR remote control sensors to function correctly. The distance between the remote control and the sensors should not exceed 6 meters (19.5 feet).

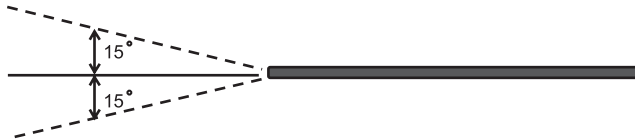

Notes on Remote Control Operation:

Make sure that there are no obstacles between the remote control and the IR sensors on the projector that might obstruct the infra-red beam.

Installing or Replacing the Battery

1. Pull out the battery holder.
2. Insert the new battery in the holder.
3. Push the holder into the remote control.

 **Avoid excessive heat and humidity. There may be danger of an explosion if the battery is incorrectly replaced. Replace only with the same or equivalent type recommended by the manufacturer. Dispose of the used battery according to the manufacturer's instructions.**





3 Connection

When connecting a signal source to the projector, be sure to:

1. Turn all equipment off before making any connections.
2. Use the correct signal cables for each source.
3. Ensure the cables are firmly inserted.

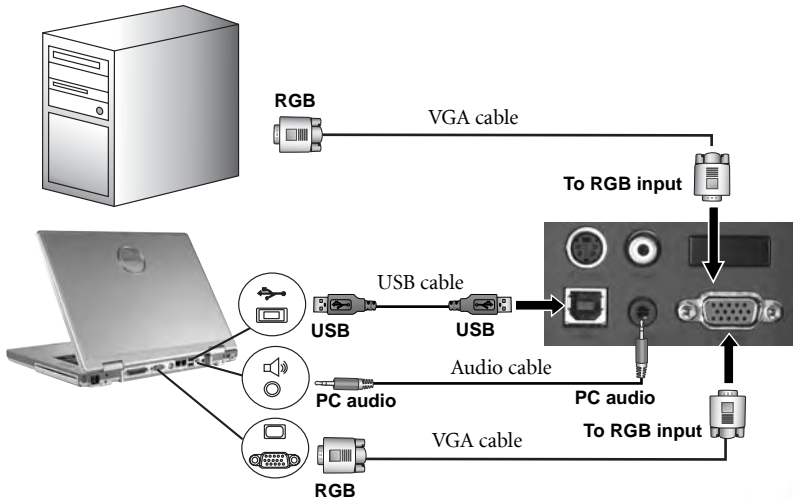
Connecting to a Laptop or Desktop Computer



 A Mac adapter (an optional accessory) is needed if you are connecting to Macintosh computers.

Connecting Equipment to the Component Video Input

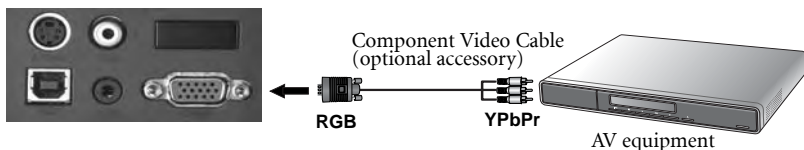

The projector is capable of displaying various High Definition TV display modes. Some of these sources are:

- Digital-VHS (D-VHS) player
- DVD player
- Satellite Dish HDTV receiver
- Digital TV tuners

Most of these sources will provide an analog component video output, a standard VGA output, or a YPbPr (default) format.

The projector is capable of accepting HDTV data through a Component video connector. Use a Component Video cable (optional accessory) to display these images.

The following standards are supported in the HDTV function:

- 480i
- 480p
- 576i
- 576p
- 720p (50/ 60 Hz)
- 1080i (50/ 60 Hz)

Connecting Video and S-Video Devices

S-Video devices

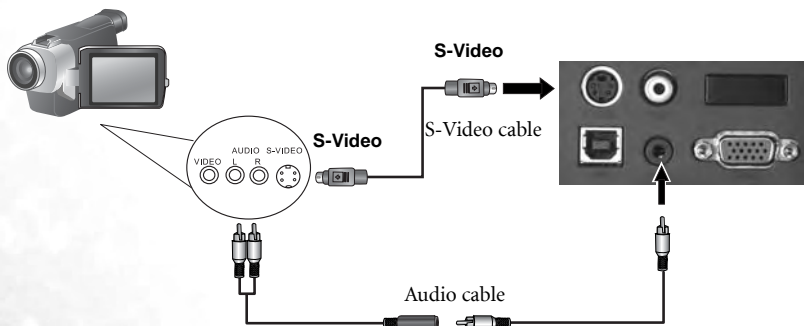

Video devices

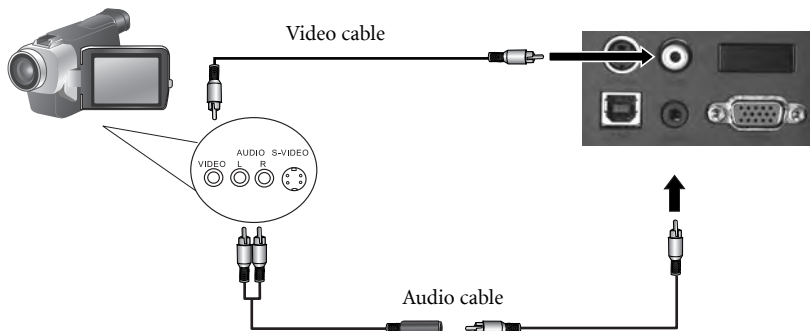

3 If the selected video image is not displayed after the projector is turned on and the correct video source has been selected, check that the video source is turned on and operating correctly. Also check that the signal cables have been connected correctly.

4 Installation

Choosing a Location

Your projector is designed to be installed in the four installation configurations shown here: Floor front, Ceiling front, Floor rear, Ceiling rear. Your room layout or personal preference will dictate which installation configuration you use.

I. Floor front

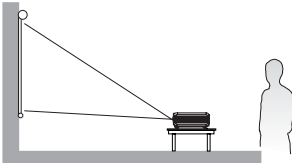

II. Ceiling front

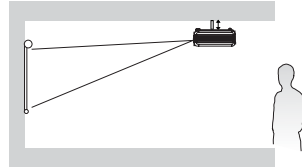

III. Floor rear

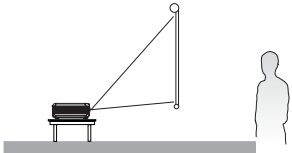

IV. Ceiling rear

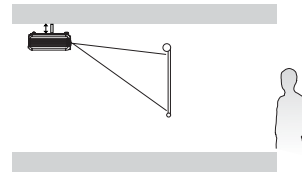

For further information on the four configurations, please refer to page [27](#).

If you place the projector above or below the screen, you have to tilt it down or up to center the image on the screen, in these situations image distortion will occur. Use the Keystone function to correct the distortion. See page [19](#) for keystone correction.

Adjusting the Height

The projector is equipped with 1 quick-release adjuster foot and 2 rear adjuster feet. These adjusters change the image height and projection angle. To adjust the projector,

1. Lift the projector up and press the adjuster button to release the adjuster. The adjuster will drop into position and be locked. It can lift the projector by up to 15 degrees.
2. Screw the rear adjuster feet to fine tune the horizontal angle.

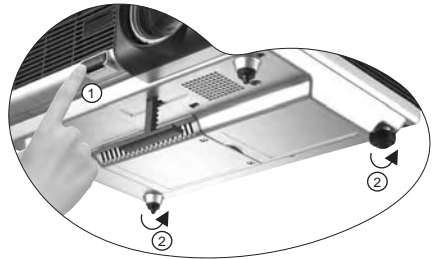

Press the adjuster button again to retract the foot.

 If the screen and the projector are not perpendicular to each other, the projected image becomes vertically trapezoidal. To correct this situation, adjust the value of Keystone in the Picture menu, on the projector control panel or on the remote control.

Screen Size

Place the projector at the required distance from the screen according to the required picture size (see the table on the next page).

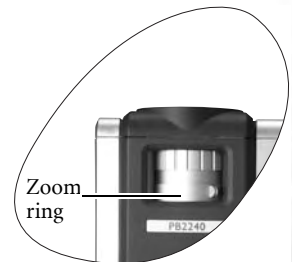
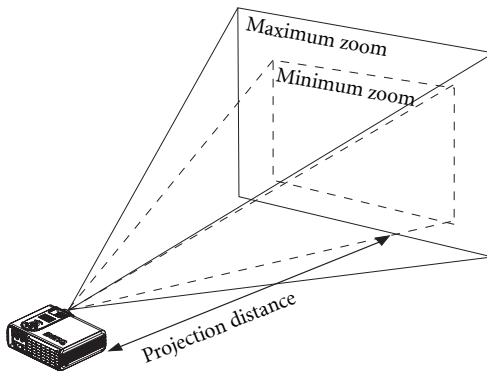

Screen size chart (4:3 aspect ratio)

Distance from screen		Diagonal measurement			
		Minimum zoom		Maximum zoom	
feet	inch	feet	inch	feet	inch
4	48	2.49	29.9	3.05	36.6
6	72	3.73	44.8	4.57	54.9
8	96	4.98	59.7	6.10	73.2
10	120	6.22	74.7	7.62	91.4
12	144	7.47	89.6	9.14	109.7
14	168	8.71	104.5	10.67	128.0
16	192	9.96	119.5	12.19	146.3
18	216	11.20	134.4	13.72	164.6
20	240	12.45	149.4	15.24	182.9
22	264	13.69	164.3	16.76	201.2
24	288	14.94	179.2	18.29	219.5
26	312	16.18	194.2	19.81	237.7
28	336	17.42	209.1	21.34	256.0
30	360	18.67	224.0	22.86	274.3
32	384	19.91	239.0	24.38	292.6
34	408	21.16	253.9	25.91	310.9

Distance from screen		Diagonal measurement			
		Minimum zoom		Maximum zoom	
meter	cm	meter	cm	meter	cm
1	100	0.62	62.2	0.76	76.2
1.5	150	0.93	93.3	1.14	114.3
2	200	1.24	124.5	1.52	152.4
2.5	250	1.56	155.6	1.91	190.5
3	300	1.87	186.7	2.29	228.6
3.5	350	2.18	217.8	2.67	266.7
4	400	2.49	248.9	3.05	304.8
4.5	450	2.80	280.0	3.43	342.9
5	500	3.11	311.2	3.81	381.0
5.5	550	3.42	342.3	4.19	419.1
6	600	3.73	373.4	4.57	457.2
6.5	650	4.04	404.5	4.95	495.3
7	700	4.36	435.6	5.33	533.4
7.5	750	4.67	466.7	5.72	571.5
8	800	4.98	497.8	6.10	609.6
8.5	850	5.40	539.8	6.48	647.7

Screen size chart (16:9 aspect ratio)

Distance from screen		Diagonal measurement			
		Minimum zoom		Maximum zoom	
feet	inch	feet	inch	feet	inch
4	48	2.29	27.5	2.80	33.6
6	72	3.44	41.3	4.20	50.4
8	96	4.59	55.1	5.60	67.2
10	120	5.74	68.8	7.00	84.0
12	144	6.88	82.6	8.40	100.8
14	168	8.03	96.4	9.80	117.6
16	192	9.18	110.1	11.20	134.4
18	216	10.32	123.9	12.60	151.2
20	240	11.47	137.7	14.00	167.9
22	264	12.62	151.4	15.39	184.7
24	288	13.77	165.2	16.79	201.5
26	312	14.91	179.0	18.19	218.3
28	336	16.06	192.7	19.59	235.1
30	360	17.21	206.5	20.99	251.9
32	384	18.35	220.3	22.39	268.7

Distance from screen		Diagonal measurement			
		Minimum zoom		Maximum zoom	
meter	cm	meter	cm	meter	cm
1	100	0.57	57.4	0.70	70.0
1.5	150	0.86	86.0	1.05	105.0
2	200	1.15	114.7	1.40	140.0
2.5	250	1.43	143.4	1.75	179.4
3	300	1.72	172.1	2.10	209.9
3.5	350	2.01	200.8	2.45	244.9
4	400	2.29	229.4	2.80	279.9
4.5	450	2.58	258.1	3.15	314.9
5	500	2.87	286.8	3.50	349.9
5.5	550	3.15	315.5	3.85	384.9
6	600	3.44	344.1	4.20	419.9
6.5	650	3.73	372.8	4.55	454.9
7	700	4.02	401.5	4.90	489.8
7.5	750	4.30	430.2	5.25	524.8
8	800	4.59	458.9	5.60	559.8

 The recommended focus range is from 1.5 ~ 8 meters (6 ~ 32 feet).

There is 3% ~ 5% tolerance among these numbers due to optical component variations.

* 1 m = 3.28 feet, 1 foot = 0.305 m, 1 m = 100 cm, 1 foot = 12 inches

5 Operation

Start Up

1. Switch all of the connected equipment on.
2. Plug the power cord into the projector and into a wall socket.

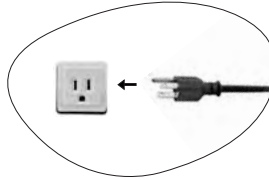

3. Turn on the wall socket switch (where fitted).
4. Press and hold **Power** on the remote control or projector to start the unit. The **Power indicator light** flashes green and stays green when the power is turned on.

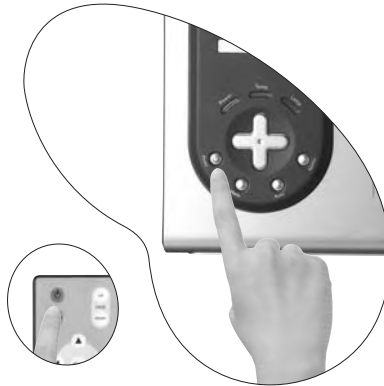

5. The start up procedure takes about 30 seconds after pressing **Power**. In the later stage of start up, a default BenQ logo appears.
6. Then, the projector starts to search for input signals. Irrespective of selected input source, the screen shows “**Acquiring Signal**” at the bottom right corner of the screen. If there is no input source detected, one of three messages will be displayed on the screen continuously: “**Analog RGB Searching**”, “**Video Searching**”, “**S-Video Searching**”.
7. You can also press **Source** on the projector or remote control to select an input signal to display if there are 2 or more devices are connected to the projector. For more information, please refer to page 20.

 **If the frequency/ resolution of the input signal exceeds the projector's operating range, you will see the message “Out of Range” displayed on a blank screen.**

Shutdown

1. Press **Power** and a warning message appears. Press **Power** a second time to turn the projector off.
2. The **Power indicator light** flashes orange and the lamp shuts down, the fans continue to run for approximately 90 seconds to cool down the projector.

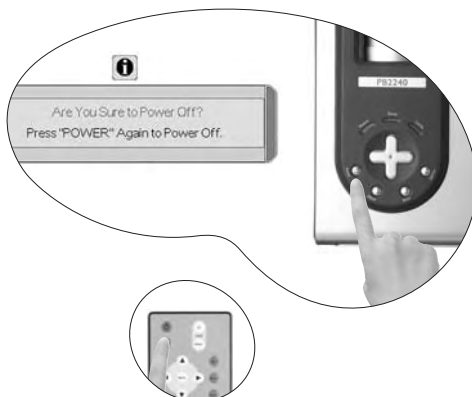

⚠ To protect the lamp, the projector will not respond to any commands during the cooling process.

3. Disconnect the power cord from the wall socket.

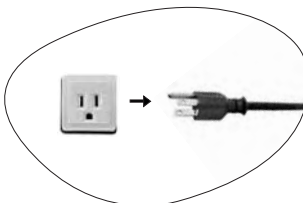

⚠ Do not unplug the power cord before the projector shutdown sequence is complete or during the 90-second cooling down process. If the projector is not properly shut down, to protect the lamp, when you attempt to re-start the projector within hours, the fans will run for a few minutes to cool down. Press Power again to start the projector after the fans stop.





Digital Keystone Correction

Keystoning refers to the situation where the projected image is noticeably wider at either the top or bottom. It occurs when the projector is not perpendicular to the screen.

To correct this, you can perform the following steps.

1. Adjust the height of the projector.
2. Press **Keystone**  on the remote control or **Auto** on the projector.

If the image is still distorted, you will need to manually correct it following ONE of these steps.

- Press **Left/ Right** (hot key) on the control panel of the projector to display the status bar labelled Keystone. Press **Left** to correct keystone at the top of the image. Press **Right** to correct keystone at the bottom of the image.
- Press  /  on the remote control to display the status bar labelled Keystone, then press  to correct keystone at the top of the image or press  to correct keystone at the bottom of the image.
- Press **Menu** key on the projector or the remote control. Go to  **Picture --> Keystone** and adjust the values by pressing **Left/ Right** on the projector or **Left/ Right** on the remote control.

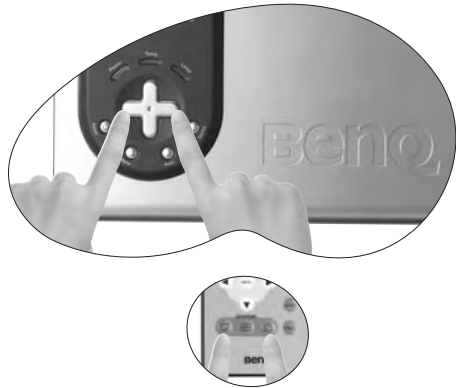

For example,



Keystone  0

1. Press **Left** on the projector or
2. Press  on the remote control or
3. Press **Left** on the projector or **Left** on the remote control when you are in Picture --> Keystone menu.



Keystone  -6



Keystone  0

1. Press **Right** on the projector or
2. Press  on the remote control or
3. Press **Right** on the projector or **Right** on the remote control when you are in Picture --> Keystone menu.



Keystone  +6

Source Selection

To sequentially select input sources, press the **Source** key on the projector control panel or the remote control. The selected source will be displayed at the bottom right of the screen for 3 seconds.

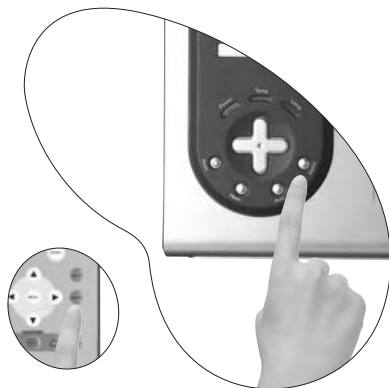

Auto Adjustment

In some cases, you may need to optimize the picture quality. To do this, press **Auto** on the control panel of the projector or on the remote control. Within 3 seconds, the built-in Intelligent Auto Adjustment function will re-adjust the values of Frequency, Clock and Keystone to provide the best picture quality.

The current source information will be displayed at the bottom right of the screen for 3 seconds, as below.



 **The screen will be blank while Auto is functioning.**

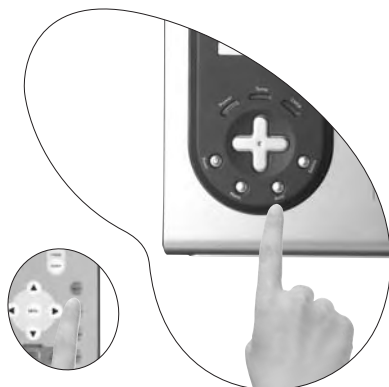

Blank

In order to draw the audience's full attention to the presenter, you can use **Blank** to hide the screen image. Press **Blank** again to restore the image. A word "**BLANK**" appear at the bottom right corner of the screen when the image is hidden.

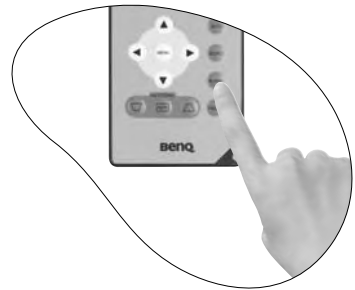

Zoom / Focusing

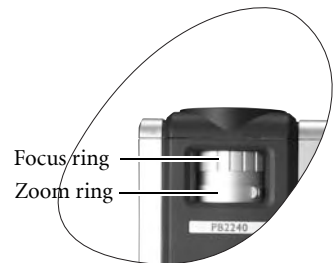

Adjust the projected image to your desired size using the lens' zoom ring. Then focus the image by rotating the focus ring. Refer to the screen size tables on page 16.



Menu Operation

Menu System

Please note that the OSD menus vary according to the signal type selected.

Functions available when receiving different signal types...		
Sub-Menu	PC	Video / S-Video / Component Video
 Picture	Preset Mode Keystone Brightness Contrast	Preset Mode Keystone Brightness Contrast Color Tint
 Pro-Picture	Auto Resize Aspect Ratio H Position V Position Phase H. Size	Auto Resize Aspect Ratio Sharpness
 Setting	Mute Volume OSD Time Reset Color Temp	
 Advance	Mirror Blank Time Source Scan Language User Logo High Altitude Mode	
 Information	Source Resolution Preset Mode Lamp Hour	Source System Preset Mode Lamp Hour

Using the Menus

The projector is equipped with on-screen display (OSD) menus for making various adjustments and settings.

There are 10 different menu languages. (Refer to page 28 for more details.)

The following example describes the adjustment of the keystone.

1. Press **Menu** to turn the on-screen menu on.
3. Adjust keystone values by pressing **Left / Right** on the projector or **Left / Right** on the remote control.

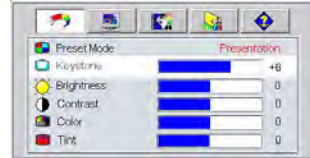
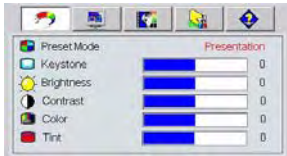

2. Use **Left / Right** on the projector or **Left / Right** on the remote control to select
4. Press **Menu** to leave and save the settings.







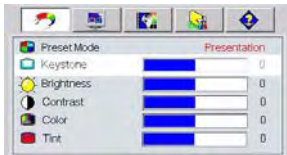



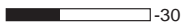

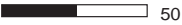

Picture and press **Up** or **Down** to

select **Keystone**.













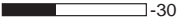



1. Picture Menu



FUNCTION	DESCRIPTION
<p>Preset Mode</p>	<p>Preset modes are provided so you can optimize your projector image set-up to suit your program type.</p> <p>PC Signal Input</p> <ol style="list-style-type: none"> Presentation Mode: Is designed for presentations. The brightness is emphasized in this mode. Vivid Mode: Is perfect for playing games. The color saturation and brightness are well-balanced. Video Mode: Is suitable for cinematic enjoyment displaying images in their natural color. Economic Mode: Use this mode to reduce system noise and reduce power consumption by 20%. The lamp life is also extended with lower light output. <p>YPbPr/ S-Video/ Video Signal Input</p> <ol style="list-style-type: none"> Gaming Mode: Is suitable for playing video games in a bright living room. Video Mode: With a higher color temperature, it is suitable for enjoying TV movies. Cinema Mode: With a lower color temperature, it is suitable for enjoying cinematic movies. Economic Mode: Use this mode to reduce system noise and reduce power consumption by 20%. The lamp life is also extended with lower light output.
<p>Keystone</p>	<p>Corrects any keystoneing of the image. Refer to page 19 for more information.</p>
<p>Brightness</p>	<p>Adjusts the brightness of the image. The higher the value, the brighter the image. And lower the setting, darker the image. Adjust this control so the black areas of the image appear just as black and that detail in the dark areas is visible.</p> <div style="display: flex; justify-content: space-around; align-items: flex-end;"> <div style="text-align: center;">   </div> <div style="text-align: center;">   </div> <div style="text-align: center;">   </div> </div>
<p>Contrast</p>	<p>Adjusts the degree of difference between dark and light in the image. The higher the value, the greater the contrast.</p> <div style="display: flex; justify-content: space-around; align-items: flex-end;"> <div style="text-align: center;">   </div> <div style="text-align: center;">   </div> <div style="text-align: center;">   </div> </div>

Color	Increases or decreases the color intensity of the image.  This function is not available when a PC input is selected.
Tint	Adjusts the color tones of the image. The higher the value, the more red-dish the image becomes. The lower the value, the more greenish the image becomes.  This function is not available when a PC input is selected.

2. Pro-Picture Menu

FUNCTION	DESCRIPTION
Auto Resize	Makes the best fit of the image to the screen. 1. On 2. Off
Aspect Ratio	There are two aspect ratio settings. 1. 4 : 3 (Standard) 2. 16 : 9 (Wide Screen)
H Position	Adjusts the horizontal position of the projected image.  This function is available only when a PC input is selected. <div style="display: flex; justify-content: space-around; align-items: flex-end;"> <div style="text-align: center;">   </div> <div style="text-align: center;">   </div> </div>
V Position	Adjusts the vertical position of the projected image.  This function is available only when a PC input is selected. <div style="display: flex; justify-content: space-around; align-items: flex-end;"> <div style="text-align: center;">   </div> <div style="text-align: center;">   </div> </div>
Phase	This function allows you to adjust the clock phase to reduce image distortion.  This function is available only when a PC input is selected. <div style="text-align: right; margin-top: 10px;">  </div>
H Size	Adjusts the horizontal width of the image.  This function is available only when a PC input is selected.
Sharpness	Adjusts the image to make it look sharper or softer.  This function is not available when a PC input is selected.

3. Setting Menu

FUNCTION	DESCRIPTION
Mute	<p>Off On</p>  
Volume	<p>Adjusts the volume level.</p> 
OSD Time	<p>Sets the length of time the OSD will remain active after your last button press. The range is from 5 to 60 seconds.</p>
Reset	<p>Returns all settings to the factory preset values.</p>
Color Temp	<p>3 color temperature* settings are available.</p> <ol style="list-style-type: none">1. Low: Makes images appear reddish white.2. Standard: Maintains normal colorings for white.3. High: Makes images appear bluish white.

***About color temperatures:**

There are many different shades that are considered to be “white” for various purposes. One of the common methods of representing white color is known as the “color temperature”. A white color with a low color temperature appears to be reddish white. A white color with a high color temperature appears to have more blue in it.

4. Advance Menu

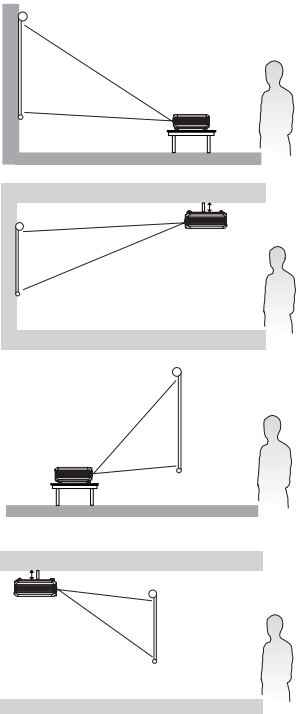
FUNCTION	DESCRIPTION
<p>Mirror</p>	<p>The projector can be installed on a ceiling or behind a screen, or with one or more mirrors. Contact your dealer for the ceiling mount bracket (optional accessory) if you need to install the projector on your ceiling.</p> <ul style="list-style-type: none"> ■ Floor front: Select this setting with the projector set on the floor and audience viewing the projected images from the front side of the screen. This is the most common setting. ■ Ceiling front: Select this setting with the projector suspended from the ceiling and audience viewing the projected images from the front side. ■ Floor rear: Select this setting when the projector is placed near the floor and behind the screen. A special rear projection screen is required. ■ Ceiling rear: Select this setting when the projector is suspended from the ceiling and placed behind the screen. A special rear projection screen is required. 
<p>Blank Time</p>	<p>Sets the image blank time when the Blank feature is activated, once elapsed the image will return to the screen.</p>
<p>Source Scan</p>	<p>Sets whether the projector searches automatically for input signals. If the source scan is on, the projector will scan for input signals in the following order: Analog RGB --> Video --> S-Video until it acquires a signal. If the function is not activated, the projector selects the last input signal.</p>
<p>Language</p>	<p>Language sets the language for the OSD control menus.</p> <p>Use ◀ Left/ Right ▶ on the projector or ◀ / ▶ on the remote control to select your desired language from among English, French, German, Italian, Spanish, Russian, Traditional Chinese, Simplified Chinese, Japanese and Korean.</p>
<p>User Logo</p>	<p>Enables the user to select which logo screen will appear during projector start-up. Three modes are available: Default (BenQ logo), black screen or blue screen.</p>

High Altitude Mode

A mode for extreme environments like high altitude and high temperature. We recommend you use the High Altitude Mode when your environment is higher than 3000 feet, or is hotter than 40°C.

Operation under "High Altitude Mode" may cause a higher decibel operating noise level because of increased fan speed necessary to improve overall system cooling and performance.

If you use this projector under other extreme environments excluding the above, it may display auto shut-down symptoms, which is designed to protect your projector from over-heating. In cases like this, you should switch to High Altitude mode to solve these symptoms. However, this is not to state that this projector can operate under any and all harsh or extreme environments.

5. Information Menu

This menu shows you the current operating status of the projector.

FUNCTION	DESCRIPTION
Source	Shows the current signal source.
Resolution	Shows the native resolution of the input signal.
Preset Mode	Shows the selected mode in  Picture menu.
Lamp Hour	Displays the number of hours the lamp has been used.
System	Shows the Video input system format, NTSC, SECAM or PAL.

6 Maintenance

Your projector needs little maintenance. Things you have to do on a regular basis are keep the lens clean.

Never remove any parts of the projector except the lamp. Contact your dealer if other parts needs replacing.

Cleaning the Lens

Clean the lens whenever you notice dirt or dust on the surface.

- Use a canister of compressed air to remove dust.
- If there is dirt or smears, use lens-cleaning paper or moisten a soft cloth with lens cleaner to gently wipe the lens surface.

 **Never rub the lens with abrasive materials.**

Cleaning the Projector Case

Before you clean the case, turn the projector off and unplug the power cord.

- To remove dirt or dust, wipe the case with a soft, dry, lint-free cloth.
- To remove stubborn dirt or stains, moisten a soft cloth with water and a neutral detergent. Then wipe the case.

 **Never use wax, alcohol, benzene, thinner or other chemical detergents. These can damage the case.**

Storing the Projector

If you need to store the projector for an extended time, please follow the instructions below.

- Make sure the temperature and humidity of the storage area are within the recommended range for the projector. Please refer to the Spec. page in the manual or consult your dealer about the range.
- Retract the adjuster feet.
- Remove the batteries from the remote control.
- Pack the projector in its original packing or equivalent.

Transporting the projector

It is recommended that you ship the projector with its original packing or equivalent. When you carry the projector yourself, please use the provided soft carry case.

Lamp Information



Warning Message

When the **Lamp indicator** lights up red or a message appears suggesting it is time to replace the lamp, please install a new lamp or consult your dealer. An old lamp may cause a malfunction in the projector and in some instances the lamp may break.

For more detailed information on lamp warnings, please refer to page 34.

 **The Lamp indicator light and Temperature warning light will light up if the lamp becomes too hot. Turn the power off and let the projector cool for 45 minutes. If the Lamp or Temp indicator still lights up after turning the power back on, please contact your dealer.**

The following Lamp warning displays will remind you to change the lamp.

Message	Status
	The lamp has been in operation for 1980 hours. Install a new lamp for optimal performance. If the projector is normally run with Preset "Economic Mode" selected (page 24), you may continue to operate the projector until the 2980 hour lamp warning appears.
	The lamp has been in operation for 2980 hours, the power will shutdown in 20 hours time. A new lamp should be fitted to avoid the inconvenience when the projector runs out of lamp time.
	The lamp has been in operation for over 3000 hours. This message will flash in the center of the screen together with the Lamp indicator lighting up red for 40 seconds. The projector will shutdown after 40 seconds. The lamp MUST be replaced before the projector will operate normally.

Replacing the Lamp

 **To reduce the risk of electrical shock, always turn the projector off and disconnect the power cord before changing the lamp.**

To reduce the risk of severe burns, allow the projector to cool for at least 45 minutes before replacing the lamp.

To reduce the risk of injuries to fingers and damage to internal components, use caution when removing lamp glass that has shattered into sharp pieces.

To reduce the risk of injuries to fingers and/or compromising image quality by touching the lens, do not touch the empty lamp compartment when the lamp is removed.

This lamp contains mercury. Consult your local hazardous waste regulations to dispose of this lamp in a proper manner.

Step 1. Turn the power off and disconnect the projector from the wall socket.

Step 2. Turn the projector over. Then loosen the screws and remove the lamp cover. If the lamp is hot, avoid burns by waiting for 45 minutes until the lamp has cooled.

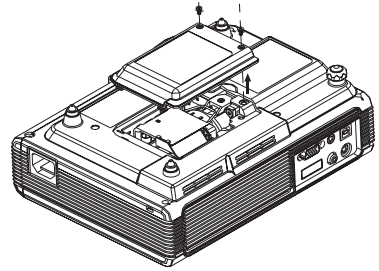

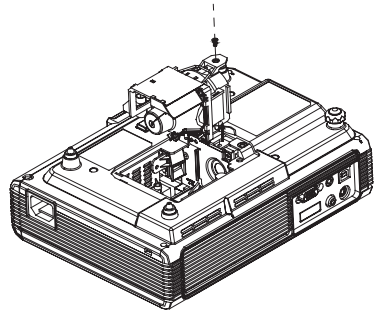

Step 3. Loosen the screw that fixing the lamp to the projector. If the screw is not loosened completely, they could injure your fingers. It is strongly recommended that you use a magnetic-head screwdriver.

Step 4. Lift the handle so that it stands up. Use the handle to slowly pull the lamp out of the projector.





 **Pulling it too quickly may cause the lamp to break and scatter broken glass in the projector.**

 **Do not place the lamp in locations where water might splash on it, children can reach it, or near flammable materials.**

 **Do not insert your hands into the projector after the lamp is removed. If you touch the optical components inside, it could cause color unevenness and distortion of the projected images.**

Step 5. Insert a new lamp. Make sure the handle is fully locked and tighten the screw firmly.

 **Loose screw may cause a bad connection, which could result in malfunction.**

 **Do not over tighten the screw.**

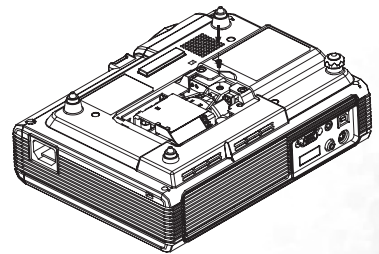



Step 6. Re-install the lamp cover and tighten the screw. **Do not turn the power on with the lamp cover removed.** Whenever the lamp is replaced, reset the total lamp operation time. **Do not reset if the lamp is not replaced as this could cause damage.**

Step 7. **Resetting the lamp counter**

i. Press and hold the  button on the projector for 5 seconds to display the total used lamp time.

ii. Press **Auto** on the projector or on the remote control to access the lamp hour timer. An adjustment message will appear.

iii. Press  or  to reset lamp hours and press **Auto** to leave.



Temp Information

When the Temperature warning light is on, it is warning you of the following possible problems:

1. The internal temperature is too high.
2. The fans are not working.

Turn the projector off and contact qualified service personnel for further help.

For more detailed information, please refer to "Indicators" on page 34.

Indicators

Illustration

1. Blank - : Light OFF







2.  : Light flashing























3.  : Light ON

4. **O** : Orange light

5. **R** : Red light

6. **G** : Green light

Light			Status & Description
Power	Temp	Lamp	
Power events			
			The projector has just been connected to a power outlet.
	-	-	(1) The projector needs 90 seconds to cool down as it was abnormally shut down without the normal cooling down process. Or (2) The projector needs to cool for 90 seconds after the power is turned off.
	-	-	Stand-by mode.
	-	-	The Power indicator light is flashing during powering up.
	-	-	The projector is under normal operation.

Lamp events			
-	-		It is warning you that lamp usage has exceeded 2000 / 3000 (Economic mode) hours. Replace the projection lamp with a new one immediately.
-	-		The lamp is not properly attached or the lamp is damaged. Please contact your dealer for assistance.
Thermal events			
		-	The projector has shutdown automatically. If you try to re-start the projector, it will shutdown again. Please contact your dealer for assistance.
			The projector has shutdown automatically. If you try to re-start the projector, it will shutdown again. Please contact your dealer for assistance.
			The projector has shutdown automatically. If you try to re-start the projector, it will shutdown again. Please contact your dealer for assistance.
		-	The projector has shutdown automatically. If you try to re-start the projector, it will shutdown again. Please contact your dealer for assistance.
			The projector has shutdown automatically. If you try to re-start the projector, it will shutdown again. Please contact your dealer for assistance.
			The projector has shutdown automatically. If you try to re-start the projector, it will shutdown again. Please contact your dealer for assistance.
-		-	The projector has shutdown automatically. If you try to re-start the projector, it will shutdown again. Please contact your dealer for assistance.
-			The projector has shutdown automatically. If you try to re-start the projector, it will shutdown again. Please contact your dealer for assistance.
-			The projector has shutdown automatically. If you try to re-start the projector, it will shutdown again. Please contact your dealer for assistance.

Service Information

Accessories (included in the standard package)

Description	Part Number
Power cord (US)	27.01818.000
Power cord (EU)	27.82718.281
Power cord (UK)	27.01018.000
Signal cable	50.J0508.503
Video cable	50.J1303.501
S-Video cable	50.72920.011
RCA R/W audio cable	50.J1311.001
PC - PC audio cable	50.L4302.501
Soft carry case	98.J2202.001
USB mouse cable	50.73213.501
Remote control	56.26J93.001
3-2 power converter	22.91007.001

Optional Accessories (not included in the standard package)

Description of parts	Partnumber
Mac adapter (switchable)	20.20118.A15
200W lamp module	60.J9301.CG1
Ceiling mount kit	60.J9319.001
Wireless Pro (EU)	59.J8201.001
Wireless Pro (US)	59.J8201.002
Presentation Plus	65.J9306.001
Component Video cable	50.J2401.001

Ordering Parts or Getting Information

For product information, product assistance, service information, or to order accessories, please visit the BenQ Corporation website at <http://www.BenQ.com>.

7 Troubleshooting

② THE PROJECTOR DOES NOT TURN ON.

Cause	Remedy
There is no power from the power cable.	Plug the power cord into the AC inlet on the projector, and plug the power cord into the power outlet. If the power outlet has a switch, make sure that it is switched on.
Attempting to turn the projector on again during the cooling process.	Wait until the cooling down process has completed.

② NO PICTURE

Cause	Remedy
The video source is not turned on or connected correctly.	Turn the video source on and check that the signal cable is connected correctly.
The projector is not correctly connected to the input source device.	Check the connection.
The input signal has not been correctly selected.	Select the correct input signal with the Source key on the projector or remote control.
The lens cap is still attached to the lens.	Remove the lens cap.

② BLURRED IMAGE

Cause	Remedy
The projection lens is not correctly focused.	Adjust the focus of the lens using the focus ring.
The projector and the screen are not aligned properly.	Adjust the projection angle and direction as well as the height of the unit if necessary.
The lens cap is still attached to the lens	Remove the lens cap.

② REMOTE CONTROL DOES NOT WORK

Cause	Remedy
The battery is out of power.	Replace the battery with a new one.
There is an obstacle between the remote control and the projector.	Remove the obstacle.
You are too far away from the projector.	Stand within 6 meters (19.5 feet) of the projector.

8 Specifications

Projector Specifications

 All specifications are subject to change without notice.

General

Product name	Digital Projector
Model name	PB2240 1024 x 768 XGA
	PB2140 800 x 600 SVGA

Optical

Display system	1-CHIP DMD
Lens F/Number	PB2240 F=2.4 to 2.6, f= 24.0 to 29.1 mm
	PB2140 F=2.4 to 2.6, f= 18.6 to 22.7 mm
Lamp	200W lamp

Electrical

Power supply	AC100 ~ 240V, 3.5A, 50/60 Hz (Automatic)
Power consumption	265W (Max)

Mechanical

Dimensions	238 mm (W) x 86.8 mm (H) x 180 mm (D)
Operating temperature range	0°C ~ 40°C
Weight	4.1 lbs (1.8 Kg)

Input terminal

Computer input	
RGB input	D-sub 15-pin (female)
Video signal input	
S-VIDEO	Mini DIN 4-pin port x 1
VIDEO	RCA jack x1
HDTV signal input	D-sub <--> YPbPr RCA jack x 3, through RGB input
Audio signal input	
Audio in	Mini jack stereo port

Output

USB mouse connector	A/B series x 1
Speaker	1 watt x 1

Environmental Requirements

Operating temperature	0°C ~ 40°C at sea level
Operating relative humidity	10% ~ 90% (without condensation)
Operating altitude	6000 feet at 30°C
	6000 ~ 10000 feet at 23°C

Dimensions

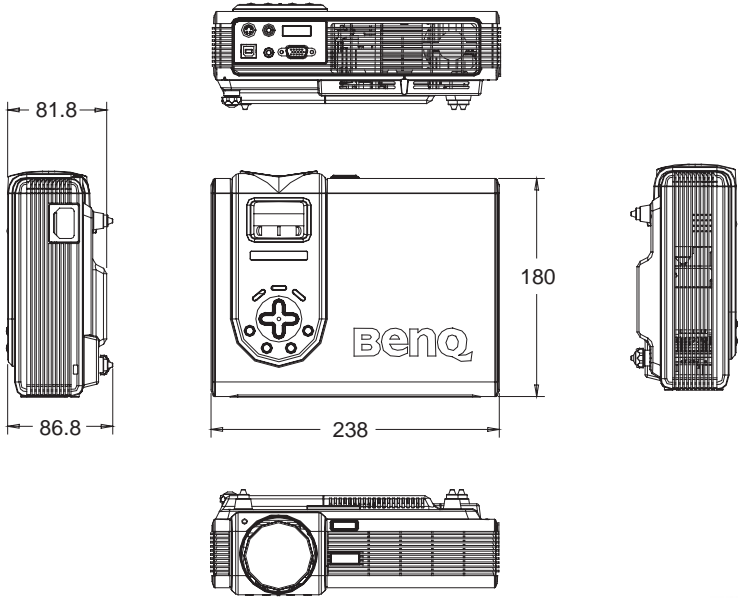

Unit: mm

Timing Chart

Supported Timing for PC Input

Resolution	Horizontal Frequency (kHz)	Vertical Frequency (Hz)	Pixel Frequency (MHz)	Mode
720 x 400	37.927	85.039	35.500	720 x 400_85
640 x 480	31.469	59.940	25.175	VGA_60
	37.861	72.809	31.500	VGA_72
	37.500	75.000	31.500	VGA_75
	43.269	85.008	36.000	VGA_85
800 x 600	37.879	60.317	40.000	SVGA_60
	48.077	72.188	50.000	SVGA_72
	46.875	75.000	49.500	SVGA_75
	53.674	85.061	56.250	SVGA_85
1024 x 768	48.363	60.004	65.000	XGA_60
	56.476	70.069	75.000	XGA_70
	60.023	75.029	78.750	XGA_75
	68.667	84.997	94.500	XGA_85
1280 x 1024	63.981	60.020	108.000	SXGA3_60

Supported Timing for Component-YPbPr Input

Signal Format	Horizontal Frequency (kHz)	Vertical Frequency (Hz)
480i(525i)@60Hz	15.73	59.94
480p(525p)@60Hz	31.47	59.94
576i(625i)@50Hz	15.63	50.00
576p(625p)@50Hz	31.25	50.00
720p(750p)@60Hz	45.00	60.00
720p(750p)@50Hz	37.50	50.00
1080i(1125i)@60Hz	33.75	60.00
1080i(1125i)@50Hz	28.13	50.00

Supported Timing for Video and S-Video Inputs

Video mode	Horizontal Frequency (kHz)	Vertical Frequency (Hz)	Color sub-carrier Frequency (MHz)
NTSC	15.73	60	3.58
PAL	15.63	50	4.43
SECAM	15.63	50	4.25 or 4.41
PAL-M	15.73	60	3.58
PAL-N	15.63	50	3.58
PAL-60	15.73	60	4.43
NTSC4.43	15.73	60	4.43

Warranty

Limited Warranty

BenQ warrants this product against any defects in material and workmanship, under normal usage and storage.

Proof of purchase date will be required with any warranty claim. In the event this product is found to be defective within the warranty period, BenQ's only obligation and your exclusive remedy shall be replacement of any defective parts (labor included). To obtain warranty service, immediately notify the dealer from which you purchased the product of any defects.

Important: The above warranty shall be void if the customer fails to operate the product in accordance with BenQ's written instructions, especially the ambient humidity must be in-between 10% and 90%, temperature in-between 0°C and 40°C, altitude lower than 10000 feet, and avoiding to operate the projector in a dusty environment. This warranty gives you specific legal rights, and you may have other rights which vary from country to country.

For other information, please refer to BenQ Warranty Information Book.

10 Regulation Statements

FCC Statement

CLASS B: This equipment generates, uses and can radiate radio frequency energy and, if not installed and used in accordance with the instructions, may cause harmful interference to radio communications. However, there is no guarantee that interference will not occur in a particular installation. If this equipment does cause harmful interference to radio or television reception, which can be determined by turning the equipment off and on, the user is encouraged to try to correct the interference by one or more of the following measures:

- Reorient or relocate the receiving antenna.
- Increase the distance between the equipment and receiver.
- Connect the equipment into an outlet on a circuit different from that to which the receiver is connected.
- Consult the dealer or an experienced radio/TV technician for help.

EEC Statement

This machine was tested against the 89/336/EEC (European Economic Community) for EMC (Electronic Magnetic Compatibility) and fulfills these requirements.

MIC Statement

B class equipment (Household purpose info/telecommunications equipment)

As this equipment has undergone EMC registration for household purpose, this product can be used in any area including residential area.