

# Panasonic®

## Operating Instructions

LCD Projector

Model No.

# PT-AE3000E

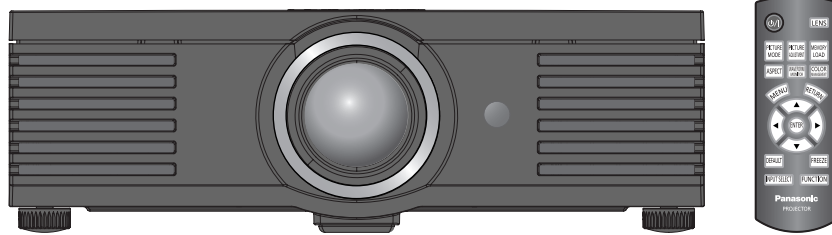

**HDMI™**  
HIGH-DEFINITION MULTIMEDIA INTERFACE

Before operating this product, please read the instructions carefully and save this manual for future use.

TQBJ0278-1

**ENGLISH**

# Important Safety Notice

## Dear Panasonic Customer:

This instruction booklet provides all the necessary operating information that you might require. We hope it will help you to get the most out of your new product, and that you will be pleased with your Panasonic LCD projector. The serial number of your product may be found on its bottom. You should note it in the space provided below and retain this booklet in case service is required.

Model number: **PT-AE3000E**

Serial number:

**WARNING:** THIS APPARATUS MUST BE EARTHED.

**WARNING:** To prevent damage which may result in fire or shock hazard, do not expose this appliance to rain or moisture.

Machine Noise Information Ordinance 3. GSGV, January 18, 1991: The sound pressure level at the operator position is equal or less than 70 dB (A) according to ISO 7779.

**WARNING:**

1. Remove the plug from the mains socket when this unit is not in use for a prolonged period of time.
2. To prevent electric shock, do not remove cover. No user serviceable parts inside. Refer servicing to qualified service personnel.
3. Do not remove the earthing pin on the mains plug. This apparatus is equipped with a three prong earthing-type mains plug. This plug will only fit an earthing-type mains socket. This is a safety feature. If you are unable to insert the plug into the mains socket, contact an electrician. Do not defeat the purpose of the earthing plug.



### Information for Users on Collection and Disposal of Old Equipment and used Batteries

These symbols on the products, packaging, and/or accompanying documents mean that used electrical and electronic products and batteries should not be mixed with general household waste.

For proper treatment, recovery and recycling of old products and used batteries, please take them to applicable collection points, in accordance with your national legislation and the Directives 2002/96/EC and 2006/66/EC.

By disposing of these products and batteries correctly, you will help to save valuable resources and prevent any potential negative effects on human health and the environment which could otherwise arise from inappropriate waste handling.

For more information about collection and recycling of old products and batteries, please contact your local municipality, your waste disposal service or the point of sale where you purchased the items. Penalties may be applicable for incorrect disposal of this waste, in accordance with national legislation.



### For business users in the European Union

If you wish to discard electrical and electronic equipment, please contact your dealer or supplier for further information.



Cd

### Information on Disposal in other Countries outside the European Union

These symbols are only valid in the European Union. If you wish to discard these items, please contact your local authorities or dealer and ask for the correct method of disposal.

### Note for the battery symbol (bottom two symbol examples):

This symbol might be used in combination with a chemical symbol. In this case it complies with the requirement set by the Directive for the chemical involved.

**CAUTION:** To assure continued compliance, follow the attached installation instructions, which includes using the provided power cord and shielded interface cables when connecting to computer or peripheral device. If you use serial port to connect PC for external control of projector, you must use optional RS-232C serial interface cable with ferrite core. Any unauthorized changes or modifications to this equipment will void the user's authority to operate.

Pursuant to at the directive 2004/108/EC, article 9(2)  
 Panasonic Testing Centre  
 Panasonic Service Europe, a division of Panasonic Marketing Europe GmbH  
 Winsbergring 15, 22525 Hamburg, F.R. Germany

**IMPORTANT: THE MOULDED PLUG (U.K. only)**

FOR YOUR SAFETY, PLEASE READ THE FOLLOWING TEXT CAREFULLY.

This appliance is supplied with a moulded three pin mains plug for your safety and convenience. A 13 amp fuse is fitted in this plug. Should the fuse need to be replaced, please ensure that the replacement fuse has a rating of 13 amps and that it is approved by ASTA or BSI to BS1362.

Check for the ASTA mark  or the BSI mark  on the body of the fuse.

If the plug contains a removable fuse cover, you must ensure that it is refitted when the fuse is replaced. If you lose the fuse cover, the plug must not be used until a replacement cover is obtained. A replacement fuse cover can be purchased from an Authorised Service Centre.

**If the fitted moulded plug is unsuitable for the mains socket in your home, then the fuse should be removed and the plug cut off and disposed of safely. There is a danger of severe electrical shock if the cut off plug is inserted into any 13 amp socket.**

If a new plug is to be fitted, please observe the wiring code as shown below.  
 If in any doubt, please consult a qualified electrician.

**WARNING:** THIS APPLIANCE MUST BE EARTHED.

**IMPORTANT:** The wires in this mains lead are coloured in accordance with the following code:

Green - and - Yellow:	Earth
Blue:	Neutral
Brown:	Live

As the colours of the wire in the mains lead of this appliance may not correspond with the coloured markings identifying the terminals in your plug, proceed as follows.

The wire which is coloured GREEN - AND - YELLOW must be connected to the terminal in the plug which is marked with the letter E or by the Earth symbol  or coloured GREEN or GREEN - AND - YELLOW.

The wire which is coloured BLUE must be connected to the terminal in the plug which is marked with the letter N or coloured BLACK.

The wire which is coloured BROWN must be connected to the terminal in the plug which is marked with the letter L or coloured RED.

How to replace the fuse: Open the fuse compartment with a screwdriver and replace the fuse.

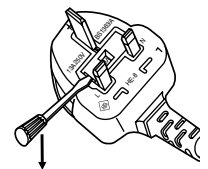

# Contents

## Quick steps

**1. Set up your projector**  
See "Setting up" on page 14.



**2. Connect with other devices**  
See "Connections" on page 18.



**3. Prepare the remote control**  
See "Remote control" on page 11.



**4. Start projecting**  
See "Switching the projector on/off" on page 19.



**5. Adjust the image**  
See "Menu Navigation" on page 29.

## Important Information

<b>Important Safety Notice</b> .....	<b>2</b>
<b>Precautions with regard to safety</b> .....	<b>6</b>
WARNINGS .....	6
CAUTIONS .....	7
Cautions when transporting .....	8
Cautions when installing .....	9
Cautions on use .....	9
Accessories .....	10

## Preparation

<b>About Your Projector</b> .....	<b>11</b>
Remote control .....	11
Projector body .....	12

## Getting Started

<b>Setting up</b> .....	<b>14</b>
Screen size and throw distance .....	14
Projection method .....	15
Front leg adjusters and throwing angle .....	15
Lens shift and positioning .....	16
<b>Connections</b> .....	<b>18</b>
Before connecting to the projector .....	18
Connecting example: COMPONENT IN/S-VIDEO IN/ VIDEO IN .....	18
Connecting example: HDMI IN/COMPUTER IN .....	18

## Basic Operation

<b>Switching the projector on/off</b> .....	<b>19</b>
Mains lead .....	19
Power indicator .....	20
Switching on the projector .....	21
Switching off the projector .....	21
<b>Projecting an image</b> .....	<b>22</b>
Selecting the input signal .....	22
Positioning the image .....	22
<b>Remote control operation</b> .....	<b>23</b>
Operating range .....	23
Managing the lens control settings .....	23
Switching the picture mode .....	23
Adjusting the image .....	23
Loading a saved setting .....	24
Switching the aspect ratio .....	24
Adjusting the signal condition with a waveform .....	24
Setting your own colour profile .....	26
Resetting to the factory default settings .....	28
Capturing an image .....	28
Switching the input signal .....	28
Using the assigned function as shortcut .....	28

## Settings

<b>Menu Navigation</b> .....	<b>29</b>
Navigating through the MENU .....	29
Main menu and sub-menu .....	30
<b>PICTURE menu</b> .....	<b>32</b>
PICTURE MODE .....	32
CONTRAST .....	32
BRIGHTNESS .....	32
COLOUR .....	32
TINT .....	32
SHARPNESS .....	32
COLOUR TEMPERATURE .....	33
DYNAMIC IRIS .....	33
WAVEFORM MONITOR .....	33
SPLIT ADJUST .....	33
ADVANCED MENU .....	34
MEMORY SAVE .....	36
MEMORY LOAD .....	36
MEMORY EDIT .....	36
SIGNAL MODE .....	36
<b>POSITION menu</b> .....	<b>37</b>
H-POSITION .....	37
V-POSITION .....	37
DOT CLOCK .....	37
CLOCK PHASE .....	37
ASPECT .....	37
WSS .....	39
OVER SCAN .....	39
KEYSTONE .....	39
AUTO SETUP .....	39
<b>LENS CONTROL</b> .....	<b>40</b>
ZOOM/FOCUS .....	40
LENS MEMORY LOAD .....	40
LENS MEMORY SAVE .....	40
LENS MEMORY EDIT .....	41
H-AREA POSITION .....	41
V-AREA POSITION .....	41
<b>FUNCTION BUTTON</b> .....	<b>42</b>
BUTTON .....	42
<b>OPTION menu</b> .....	<b>43</b>
INPUT GUIDE .....	43
OSD DESIGN .....	43
OSD POSITION .....	43
BACK COLOUR .....	43
STARTUP LOGO .....	43
AUTO SEARCH .....	43
HDMI SIGNAL LEVEL .....	43
FRAME RESPONSE .....	43
INSTALLATION .....	44
SLEEP .....	44
HIGH ALTITUDE MODE .....	44
LAMP POWER .....	44
LAMP RUNTIME .....	44

## Maintenance

<b>TEMP and LAMP Indicators</b> .....	<b>45</b>
Managing the indicated problems .....	45
<b>Care and Replacement</b> .....	<b>46</b>
Cleaning the projector .....	46
Replacing the lamp unit .....	47
<b>Troubleshooting</b> .....	<b>49</b>

## Appendix

<b>Technical Information</b> .....	<b>50</b>
List of compatible signals .....	50
Serial terminal .....	51
Specifications .....	54
Ceiling mount bracket safeguards .....	56
Dimensions .....	57
Trademark acknowledgements .....	57
<b>Index</b> .....	<b>58</b>

# Precautions with regard to safety

## WARNINGS

**If you notice smoke, strange smells or noise coming from the projector, disconnect the mains plug from the mains socket.**

- Do not continue to use the projector in such cases, otherwise fire or electric shocks could result.
- Check that no more smoke is coming out, and then contact an Authorised Service Centre for repairs.
- Do not attempt to repair the projector yourself, as this can be dangerous.

**Do not install this projector in a place which is not strong enough to take the full weight of the projector.**

- If the installation location is not strong enough, it may fall down or tip over, and severe injury or damage could result.

**Installation work (such as ceiling suspension) should only be carried out by a qualified technician.**

- If installation is not carried out correctly, there is the danger that injury or electric shocks may occur.
- Do not use other than an authorised ceiling mount bracket.

**If foreign objects or water get inside the projector, or if the projector is dropped or the cabinet is broken, disconnect the mains plug from the mains socket.**

- Continued use of the projector in this condition may result in fire or electric shocks.
- Contact an Authorised Service Centre for repairs.

**The mains socket shall be installed near the equipment and shall be easily accessible.**

- Unplug the mains plug from the mains socket immediately when problem occurred.

**Do not overload the mains socket.**

- If the power supply is overloaded (for example, by using too many adapters), overheating may occur and fire may result.

**Never attempt to modify or disassemble the projector.**

- High voltages can cause fire or electric shocks.
- For any inspection, adjustment and repair work, please contact an Authorised Service Centre.

**Clean the mains plug regularly to prevent it from becoming covered in dust.**

- If dust builds up on the mains plug, the resulting humidity can damage the insulation, which could result in fire. Pull the mains plug out from the mains socket and wipe it with a dry cloth.
- If not using the projector for an extended period of time, pull the mains plug out from the mains socket.

**Do not handle the mains plug with wet hands.**

- Failure to observe this may result in electric shocks.

**Insert the mains plug securely into the mains socket.**

- If the plug is not inserted correctly, electric shocks or overheating could result.
- Do not use damaged plugs or loose mains socket.

**Do not place the projector on top of surfaces which are unstable.**

- If the projector is placed on top of a surface which is sloped or unstable, it may fall down or tip over, and injury or damage could result.

**Do not place the projector into water or let it become wet.**

- Failure to observe this may result in fire or electric shocks.

**Do not do anything that might damage the mains lead or the mains plug.**

- Do not damage the mains lead, make any modifications to it, place it near any hot objects, bend it excessively, twist it, pull it, place heavy objects on top of it or wrap it into a bundle.
- If the mains lead is used while damaged, electric shocks, short-circuits or fire may result.
- Ask an Authorised Service Centre to carry out any repairs to the mains lead that might be necessary.

**Do not place the projector on soft materials such as carpets or sponge mats.**

- Doing so may cause the projector to overheat, which can cause burns, fire or damage to the projector.

**Do not place liquid containers on top of the projector.**

- If water spills onto the projector or gets inside it, fire or electric shocks could result.
- If any water gets inside the projector, contact an Authorised Service Centre.

**Do not insert any foreign objects into the projector.**

- Do not insert any metal objects or flammable objects into the projector or drop them onto the projector, as doing so can result in fire or electric shocks.

**Do not allow the + and - terminals of the batteries to come into contact with metallic objects such as necklaces or hairpins.**

- Failure to observe this may cause the batteries to leak, overheat, explode or catch fire.
- Store the batteries in a plastic bag and keep them away from metallic objects.

## Precautions with regard to safety

### Do not touch the leaked liquid from the batteries.

- If you touch the leaked liquid, it may hurt your skin. Immediately wash away the liquid with water and seek medical advice.
- If you get the leaked liquid in your eye, it may cause blindness or damage. Never rub your eye, and immediately wash away the liquid with water and seek medical advice.

### During a thunderstorm, do not touch the projector or the cable.

- Electric shocks can result.

### Do not use the projector in a bath or shower.

- Fire or electric shocks can result.

### Do not place your skin into the light beam while the projector is being used.

- Strong light is emitted from the projector's lens. If you place directly into this light, it can hurt or damage your skin.

### Do not look into the lens while the projector is being used.

- Strong light is emitted from the projector's lens. If you look directly into this light, it can hurt and damage your eyes.
- Be especially careful not to let young children look into the lens. In addition, turn off the power and disconnect the mains plug when you are away from the projector.

### Do not place your hands or other objects close to the air outlet port.

- Heated air comes out of the air outlet port. Do not place your hands or face, or objects which cannot withstand heat close to this port [allow at least 50 cm (20") of space], otherwise burns or damage could result.

### Replacement of the lamp is recommended to be carried out by a qualified technician.

- The lamp has high internal pressure. If improperly handled, explosion might result.
- The lamp can easily become damaged if struck against hard objects or dropped, and injury or malfunctions may result.

### When replacing the lamp, allow it to cool for at least one hour before handling it.

- The lamp cover gets very hot, and touching it can cause burns.

### Before replacing the lamp, be sure to disconnect the mains plug from the mains socket.

- Electric shocks or explosions can result if this is not done.

### Do not allow infants or pets to touch the remote control unit.

- Keep the remote control unit out of the reach of infants and pets after using it.

## CAUTIONS

### Do not cover the air inlet port or the air outlet port.

- Doing so may cause the projector to overheat, which can cause fire or damage to the projector.
- Do not place the projector in narrow, badly ventilated places such as closets or bookshelves.
- Do not place the projector on cloth or papers, as these materials could be drawn into the air inlet port.

### Do not set up the projector in humid or dusty places or in places where the projector may come into contact with oily smoke or steam.

- Using the projector under such conditions may result in fire, electric shocks or plastic deterioration. The plastic deterioration may cause the falling down of the projector which is mounted on the ceiling.

### Do not set up the projector in a high temperature environment, such as near a heater or in direct sunlight.

- Failure to observe this may result in fire, malfunction or plastic deterioration.

### Do not set up the projector outdoors.

- The projector is designed for indoor use only.

### When disconnecting the mains lead, hold the plug, not the lead.

- If the mains lead itself is pulled, the lead will become damaged, and fire, short-circuits or serious electric shocks may result.

### Always disconnect all cables before moving the projector.

- Moving the projector with cables still attached can damage the cables, which could cause fire or electric shocks to occur.

### Do not place any heavy objects on top of the projector.

- Failure to observe this may cause the projector to become unbalanced and fall, which could result in damage or injury.

## Precautions with regard to safety

### Do not short-circuit, heat or disassemble the batteries or place them into water or fire.

- Failure to observe this may cause the batteries to overheat, leak, explode or catch fire, and burns or other injury may result.

### When inserting the batteries, make sure the polarities (+ and -) are correct.

- If the batteries are inserted incorrectly, they may explode or leak, and fire, injury or contamination of the battery compartment and surrounding area may result.

### Use only the specified batteries.

- If incorrect or different kinds of batteries are used, they may explode or leak, and fire, injury or contamination of the battery compartment and surrounding area may result.

### Do not mix old and new batteries.

- If the batteries are inserted incorrectly, they may explode or leak, and fire, injury or contamination of the battery compartment and surrounding area may result.

### Remove the used batteries from the remote control promptly.

- If you leave used batteries in the remote control for an extended period of time, it may cause liquid leaking, abnormal internal temperature rising or explosion.

### If not using the projector for an extended period of time, disconnect the mains plug from the mains socket and remove the batteries from the remote control.

- If dust builds up on the mains plug, the resulting humidity may damage the insulation, which could result in fire.
- Keeping or leaving the remote control with batteries inside may cause insulation deterioration, electrical leakage or explosion which could result in fire.

We are constantly making efforts to preserve and maintain a clean environment. Please take non repairable units back to your dealer or a recycling company.

## Cautions when transporting

### Do not subject the projector to excessive vibration or shocks.

- The projector lens needs to be handled with care.
- Cover the lens with the lens cover when transporting the projector.

### Do not put your weight on this projector.

- You could fall or the projector could break, and injury may result.
- Be especially careful not to let young children stand or sit on the projector.

### Disconnect the mains plug from the mains socket as a safety precaution before carrying out any cleaning.

- Electric shocks can result if this is not done.

### If the lamp has broken, ventilate the room immediately. Do not touch or bring your face close to the broken pieces.

- Failure to observe this may cause the user to absorb the gas which was released when the lamp broke and which contains nearly the same amount of mercury as fluorescent lamps, and the broken pieces may cause injury.
- If you believe that you have absorbed the gas or that the gas has got into your eyes or mouth, seek medical advice immediately.
- Ask your dealer about the replacement of the lamp unit and check the inside of the projector.

### Ask an Authorised Service Centre to clean inside the projector at least once a year.

- If dust is left to build up inside the projector without being cleaned out, it can result in fire or problems with operation.
- It is a good idea to clean the inside of the projector before the season for humid weather arrives. Ask your nearest Authorised Service Centre to clean the projector when required. Please discuss with the Authorised Service Centre regarding cleaning costs.



## Cautions when installing

### Avoid setting up in places which are subject to vibration or shocks.

- The internal parts can be damaged, which may cause malfunctions or accidents.

### Avoid setting up in places which are subject to sudden temperature changes, such as near an air conditioner or lighting equipment.

- The life of the lamp may be shortened or the projector may be turned off. See "TEMP indicator" on page 45.

### Do not set up the projector near high-voltage power lines or near motors.

- The projector may be subject to electromagnetic interference.

### If installing the projector to the ceiling, ask a qualified technician or an Authorised Service Centre to carry out all installation work.

- You will need to purchase the separate installation kit (Model No. ET-PKE2000, ET-PKE1000S). Furthermore, all installation work should only be carried out by a qualified technician.
- See "Ceiling mount bracket safeguards" on page 56 for the safety cable installation.

### If using this projector at high elevations 1 400 - 2 700 m (4 593 - 8 858 ft) sea level, set the HIGH ALTITUDE MODE to ON. See "HIGH ALTITUDE MODE" on page 44.

- Failure to observe this may result in malfunctions or the life of the lamp or the other components may be shortened.

## Cautions on use

### In order to get the best picture quality

- Draw curtains or blinds over any windows and turn off any lights near the screen to prevent outside light or light from indoor lamps from shining onto the screen.

### Do not touch the surfaces of the lens with your bare hands.

- If the surface of the lens becomes dirty from fingerprints or anything else, this will be magnified and projected onto the screen. Moreover, when not using the projector, attach the lens cover.

### Liquid crystal panel

- Do not project the same image for long periods of time, as this may remain as an afterimage on the liquid crystal panel. Display the white screen test pattern for more than an hour to remove it. See "ZOOM/FOCUS" on page 40.
- The liquid crystal panel of the projector is built with very high precision technology to provide fine picture details. Occasionally, a few stuck pixels may appear on the screen as fixed points of blue, green or red. It is recommended to switch off the projector once and try after 1 hour later again. Please note that this does not affect the performance of your LCD.

### The projector has a high pressure mercury lamp and that is characterised as follows.

- The brightness of the lamp depends on the duration of use.
- The lamp may explode or shorten the lamp life by shocks or chipping damage.
- The lamp may explode only occasionally after using the projector.
- The lamp may explode if using the projector after the instructed lamp replacement timing.
- When the lamp exploded, it emits the internal smoke-like gas.
- The lamp life depends on individual lamp characteristics, usage condition and the installation environment. Especially the consecutive use of the projector for more than 10 hours, or the frequent switching on or off may greatly affect on the lamp life.

### Optical components

- If you use the projector consecutively 6 hours every day, the optical components may need to be replaced in less than 1 year.

## Precautions with regard to safety

### Accessories

Make sure the following accessories are provided with your projector.

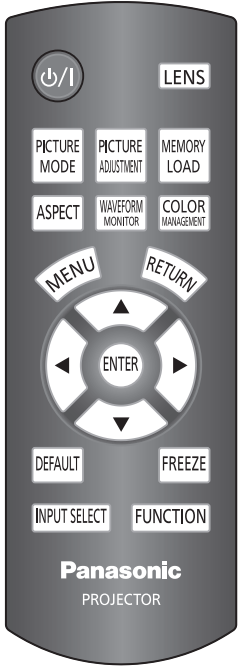
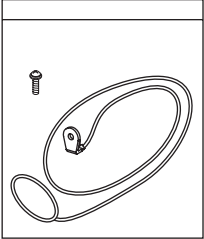
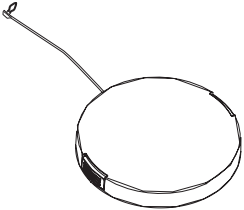
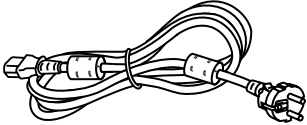
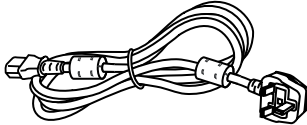
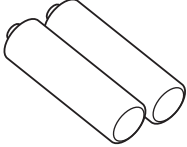
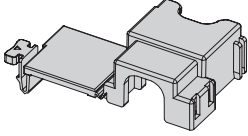
<p><b>Remote control</b> for PT-AE3000E (x1) N2QAYB000316</p> 	<p><b>Safety cable</b> TTRA0141 Attachment screw (x1) Safety cable (x1)</p> 	<p><b>Lens cover</b> (x1) TXFKK01VKF5 (Attached to the projector by default.)</p> 
	<p><b>Mains lead for continental Europe</b> (x1) K2CM3FH00001 3 m (9'10")</p> 	<p><b>Mains lead for UK</b> (x1) K2CT3FH00003 3 m (9'10")</p> 
	<p><b>AA batteries</b> for remote control (x2)</p> 	<p><b>Power cord secure lock</b> (x1) TTRA0184</p> 

\* The protectors for enclosed products, such as a plug cover or foam cartons, must be treated properly.

\* Contact to an Authorised Service Centre for lost accessories.

# About Your Projector

## Remote control

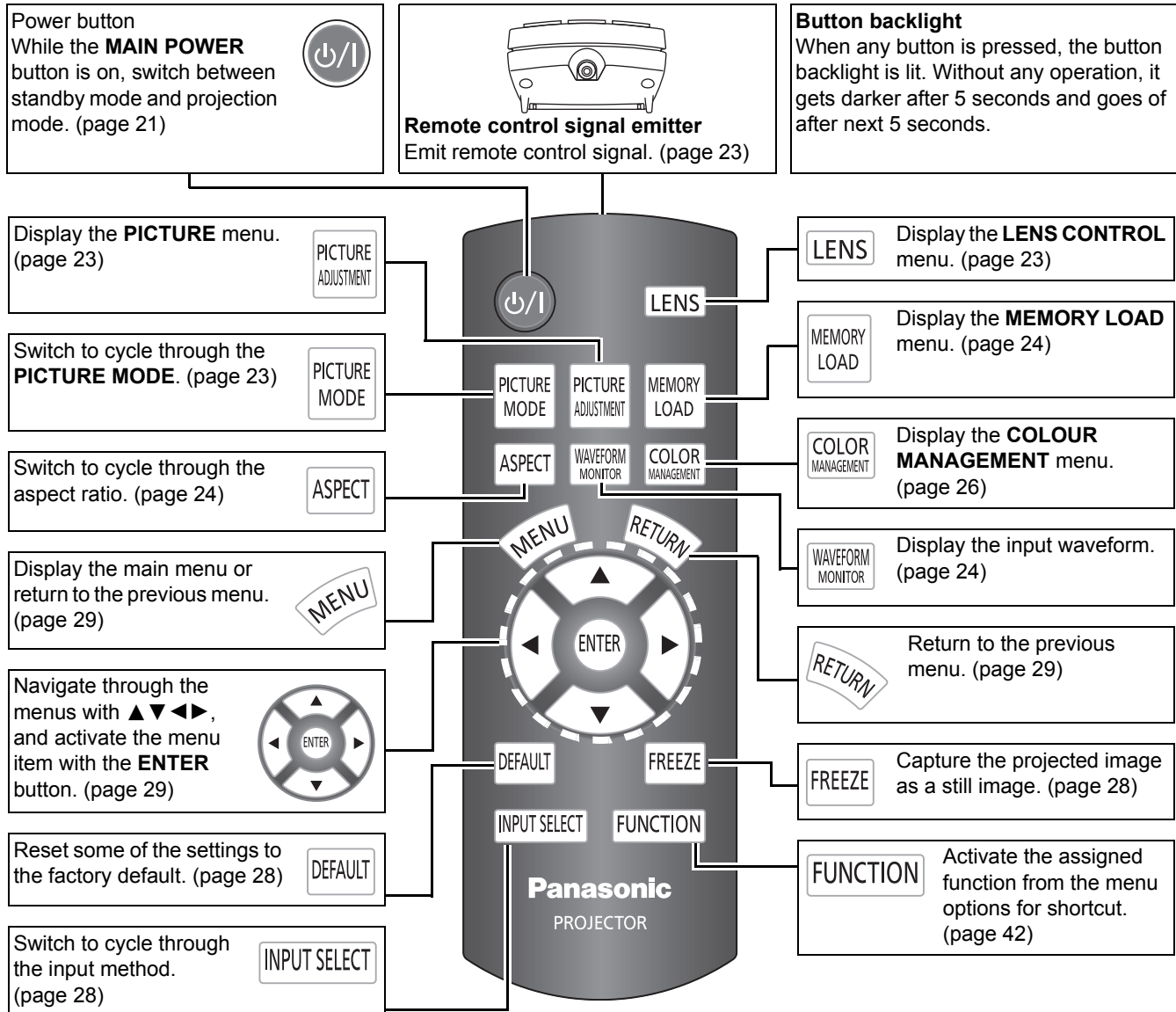

### Battery compartment

1. Press the tab and lift up the cover.
2. Insert the batteries according to the polarity diagram indicated inside.

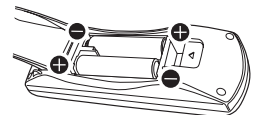
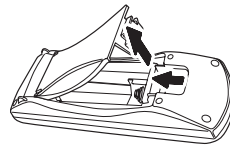

### NOTE:

- Do not drop the remote control.
- Avoid contact with liquids or moisture.
- Use manganese batteries or alkaline batteries with the remote control.
- Do not attempt to modify or disassemble the remote control. Contact an Authorised Service Centre for repairs.
- Do not keep pressing the remote control buttons as this may shorten battery life.
- See "Remote control operation" on page 23.

# About Your Projector

## Projector body

### Top and front view

Preparation

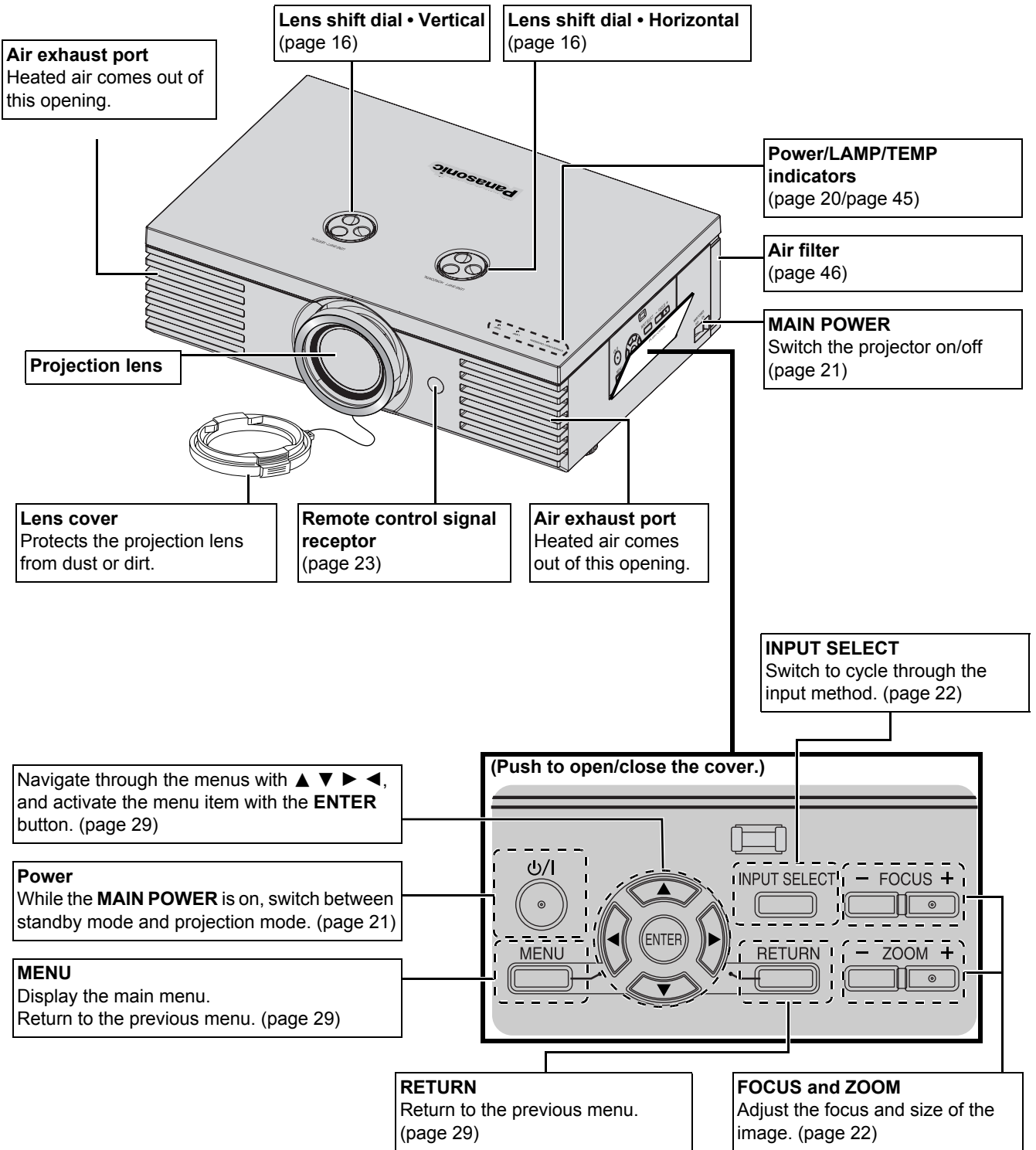

#### NOTE:

- Do not cover the ventilation openings or place anything within 50 cm (20") of them as this may cause damage or injury.
- While the projector is not in use, keep the lens cover to protect the lens.

Back and bottom view

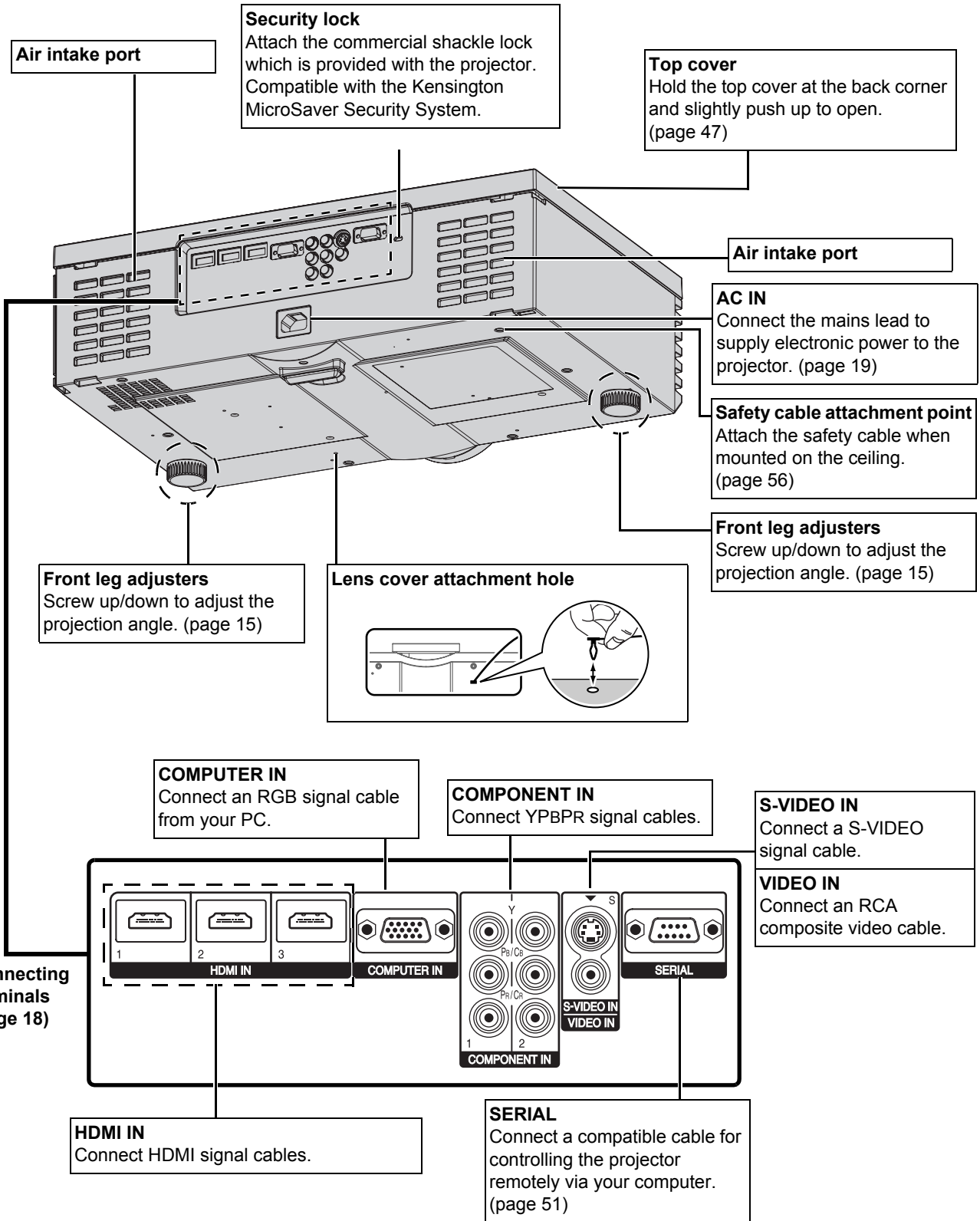

**NOTE:**

- Do not cover the ventilation openings or place anything within 50 cm (20") of them as this may cause damage or injury.
- The projector should only be used with the attached mains lead to ensure optimum performance and avoid damage to the projector.
- Do not open the top cover other than replacing the lamp unit.

# Setting up

## Screen size and throw distance

You can adjust the projection size with 2.0x zoom lens. Calculate and define the throw distance as follows.

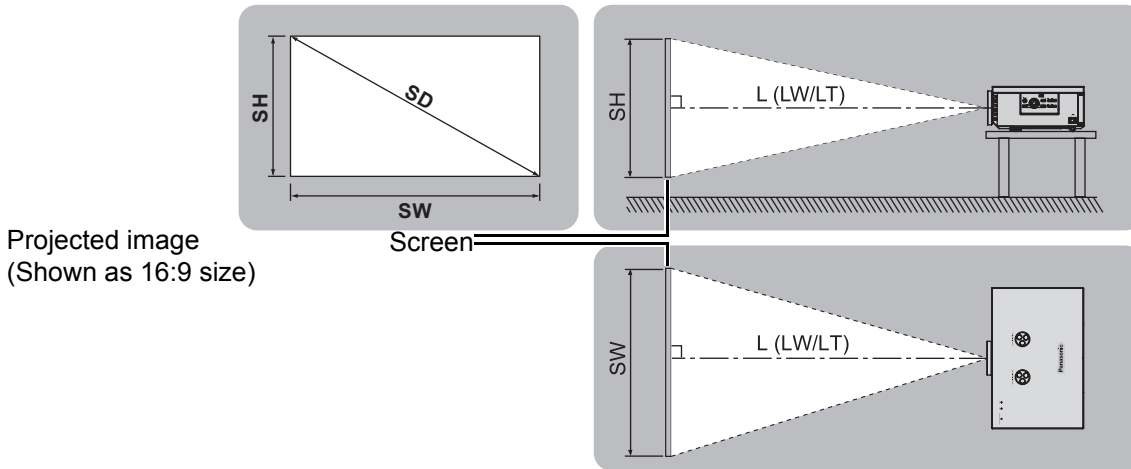

All measurements and the calculation results below are approximate and may differ from the actual measurements.

Screen Diagonal (SD)	Throw distance (16 : 9)		Throw distance (2.35 : 1)	
	Minimum distance (LW)	Maximum distance (LT)	Minimum distance (LW)	Maximum distance (LT)
1.01 m (40")	1.2 m (3'11")	2.3 m (7'6")	1.3 m (4'3")	2.5 m (8'2")
1.27 m (50")	1.5 m (4'11")	2.9 m (9'6")	1.6 m (5'2")	3.1 m (10'2")
1.52 m (60")	1.8 m (5'10")	3.5 m (11'5")	1.9 m (6'2")	3.7 m (12'1")
1.77 m (70")	2.1 m (6'10")	4.1 m (13'5")	2.2 m (7'2")	4.4 m (14'5")
2.03 m (80")	2.4 m (7'10")	4.7 m (15'5")	2.6 m (8'6")	5 m (16'4")
2.28 m (90")	2.7 m (8'10")	5.3 m (17'4")	2.9 m (9'6")	5.6 m (18'4")
2.54 m (100")	3 m (9'10")	5.9 m (19'4")	3.2 m (10'5")	6.3 m (20'8")
3.05 m (120")	3.6 m (11'9")	7.2 m (23'7")	3.8 m (12'5")	7.6 m (24'11")
3.81 m (150")	4.5 m (14'9")	9 m (29'6")	4.8 m (15'8")	9.5 m (31'2")
5.08 m (200")	6 m (19'8")	12 m (39'4")	6.4 m (20'11")	12.7 m (41'8")

### Calculation methods for screen dimensions

You can calculate more detailed screen dimension from the screen diagonal.

- 16 : 9 size

Screen width (SW) and screen height (SH)

$$SW (m) = SD (m) \times 0.872$$

$$SH (m) = SD (m) \times 0.490$$

Minimum distance (LW) and maximum distance (LT)

$$LW (m) = SD (m) \times 1.189 - 0.04$$

$$LT (m) = SD (m) \times 2.378 - 0.05$$

- 2.35 : 1 size

Screen width (SW) and screen height (SH)

$$SW (m) = SD (m) \times 0.920$$

$$SH (m) = SD (m) \times 0.392$$

Minimum distance (LW) and maximum distance (LT)

$$LW (m) = SD (m) \times 1.256 - 0.04$$

$$LT (m) = SD (m) \times 2.512 - 0.05$$

#### NOTE:

- Do not use the projector at a raised or a horizontally tilted position as it may cause malfunction of the projector.
- Make sure the projector lens surface is parallel with the screen. You can tilt the projector body less than approximately  $\pm 30^\circ$  vertically. Overtilting may result in shortening the component's life.
- For the best quality of the projection image, install a screen where sun light or room light does not shine directly onto the screen. Close window shades or curtains to block the lights.

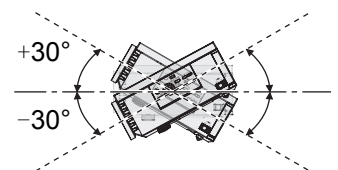

## Projection method

You can use the projector with any of the following 4 projection methods. To set the desired method in the projector, See "INSTALLATION" on page 44.

### ■ Setting on a desk/floor and projecting from front

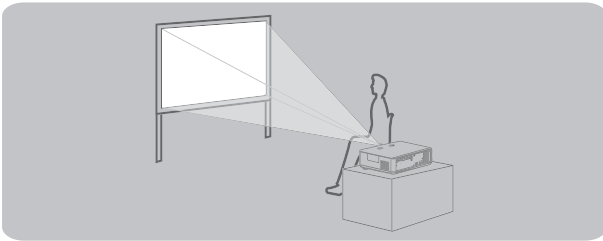

INSTALLATION: FRONT/DESK

### ■ Setting on a desk/floor and projecting from rear

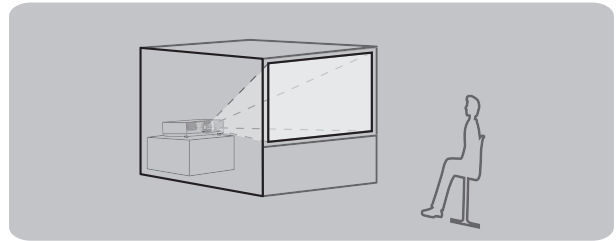

INSTALLATION: REAR/DESK

### ■ Mounting on the ceiling and projecting from front

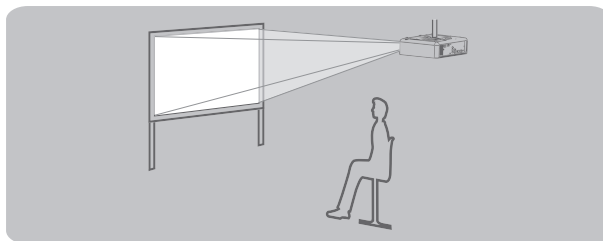

INSTALLATION: FRONT/CEILING

### ■ Mounting on the ceiling and projecting from rear

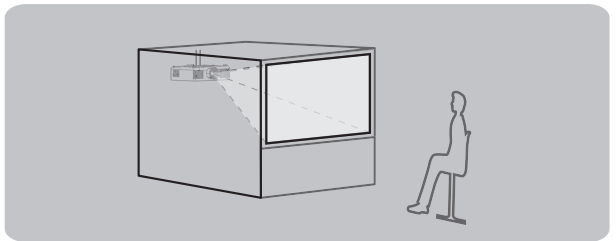

INSTALLATION: REAR/CEILING

#### NOTE:

- A translucent screen is required for rear projection.
- When mounting the projector on the ceiling, the optional ceiling mount bracket (ET-PKE2000, ET-PKE1000S) is required.
- See "Ceiling mount bracket safeguards" on page 56.

## Front leg adjusters and throwing angle

You can screw up/down the front leg adjusters to control the angle of the projector for adjusting the throwing angle. See "Positioning the image" on page 22.

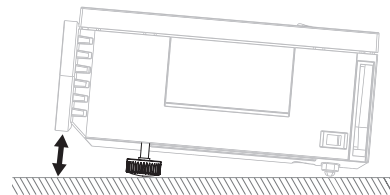
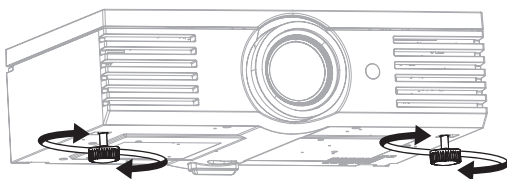

#### NOTE:

- Heated air comes out of the air exhaust port. Do not touch the air exhaust port directly.
- If keystone distortion occurs, see "KEYSTONE" on page 39.
- Screw up the adjuster legs, and an audible click will be heard as the limit.

## Lens shift and positioning

If the projector is not positioned at the right angle to the centre of the screen, you can adjust the projected image position by moving the lens shift dials within the shift range of the lens.

### ■ Adjusting the lens shift dials

#### ● Horizontal shift

You can place the projector where the projector lens is up to 40% horizontally off-centre from the screen and then adjust the image position with the **Lens shift dial • Horizontal**.

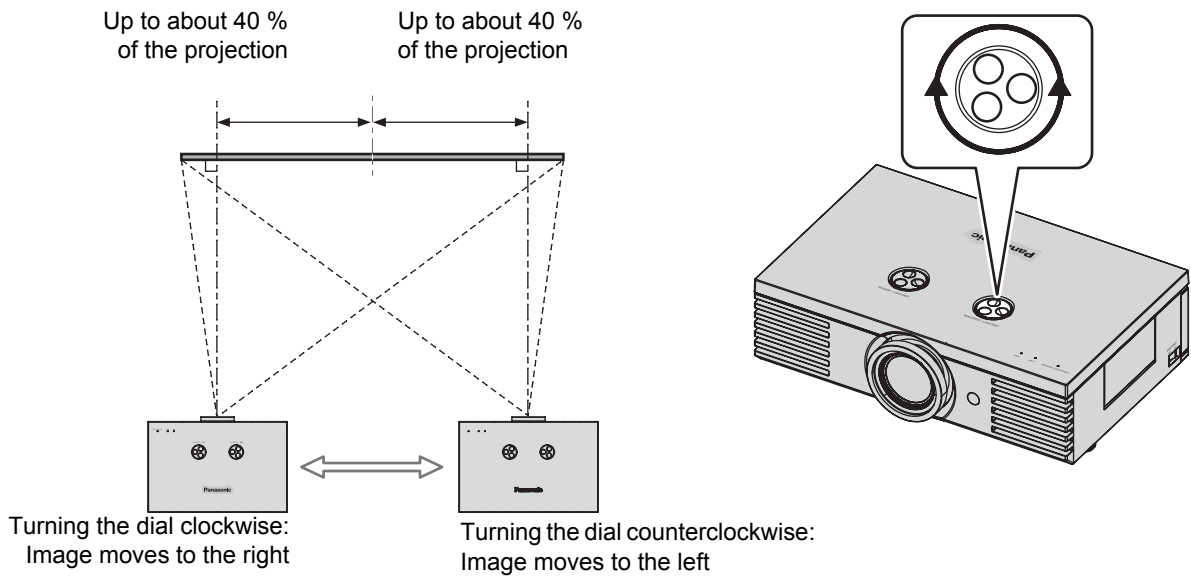

#### ● Vertical shift

You can place the projector where the projector lens is up to 100% vertically off-centre from the screen and then adjust the image position with the **Lens shift dial • Vertical**.

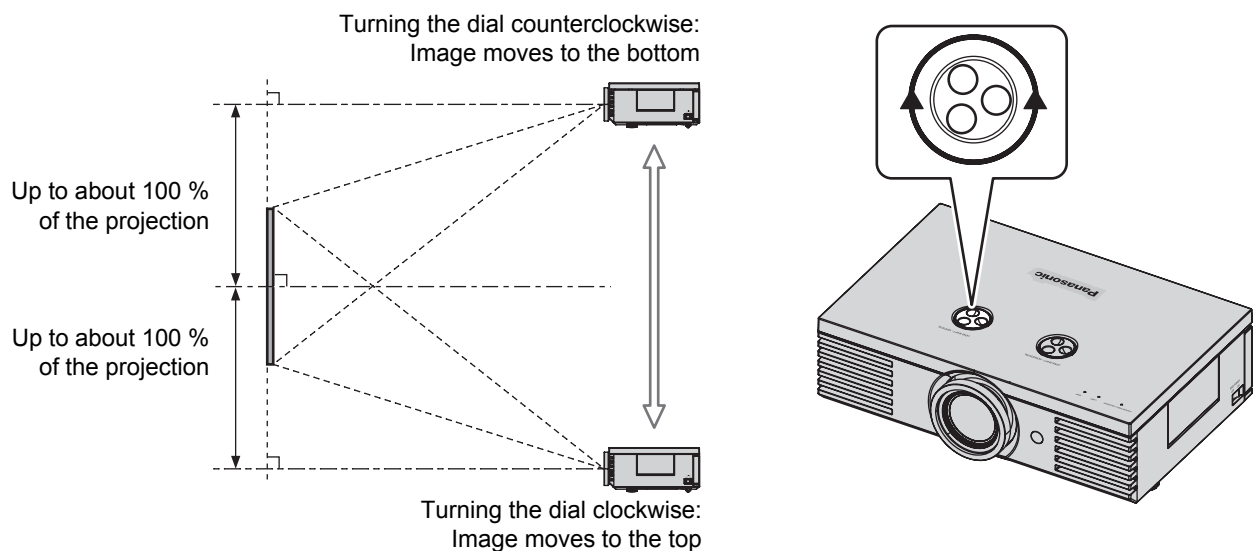



## Projector location range

You can determine where to locate the screen and the projector by considering the lens shift possibilities.

### When the screen position is fixed

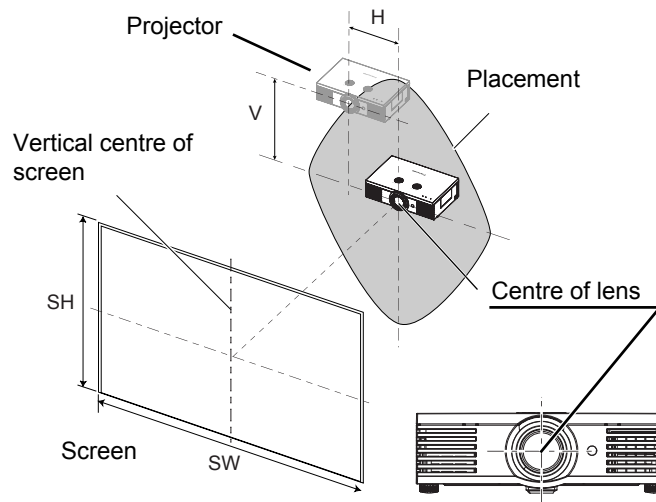

### When the projector position is fixed

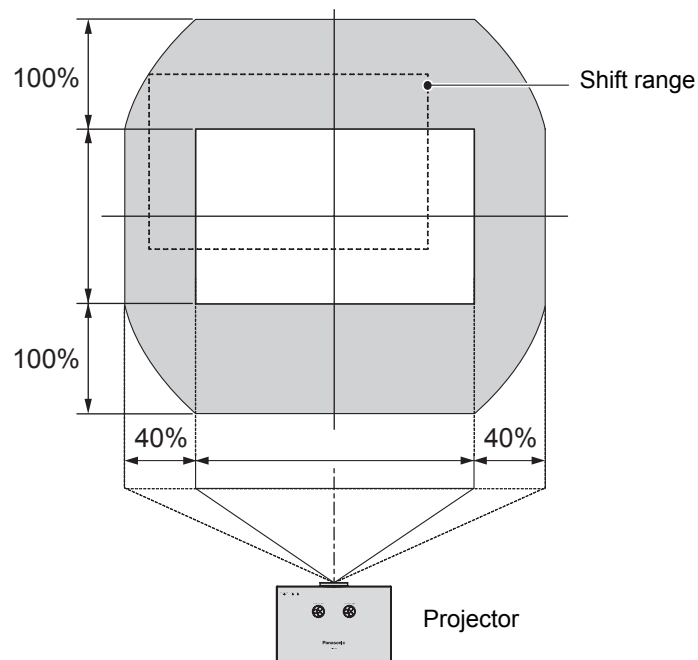

#### NOTE:

- When the projector is located at the right angle to the centre of the screen and the lens shift dials are centred, you will get the best quality of the projection image.
- When the **Lens shift dial • Vertical** is at the vertical limit of the shift range, you cannot turn the dial to the horizontal limit, likewise when the **Lens shift dial • Horizontal** is at the horizontal limit of the shift range, you cannot turn the dial to the vertical limit.
- When the projector is tilted and you adjust **KEYSTONE**, the centre of the screen and the lens need to be realigned.
- Do not force the lens shift dials to turn as this may damage the projector. Turning the dials maximum limit is 4 or 5 times from the default position.

# Connections

## Before connecting to the projector

- Read and follow the operating and connecting instructions of each peripheral device.
- The peripheral devices must be turned off.
- Use cables that match each peripheral device to be connected.
- Confirm the type of video signals. See “List of compatible signals” on page 50.
- Audio cables must be connected from each peripheral device directly to the audio reproduction system.

## Connecting example: COMPONENT IN/S-VIDEO IN/VIDEO IN

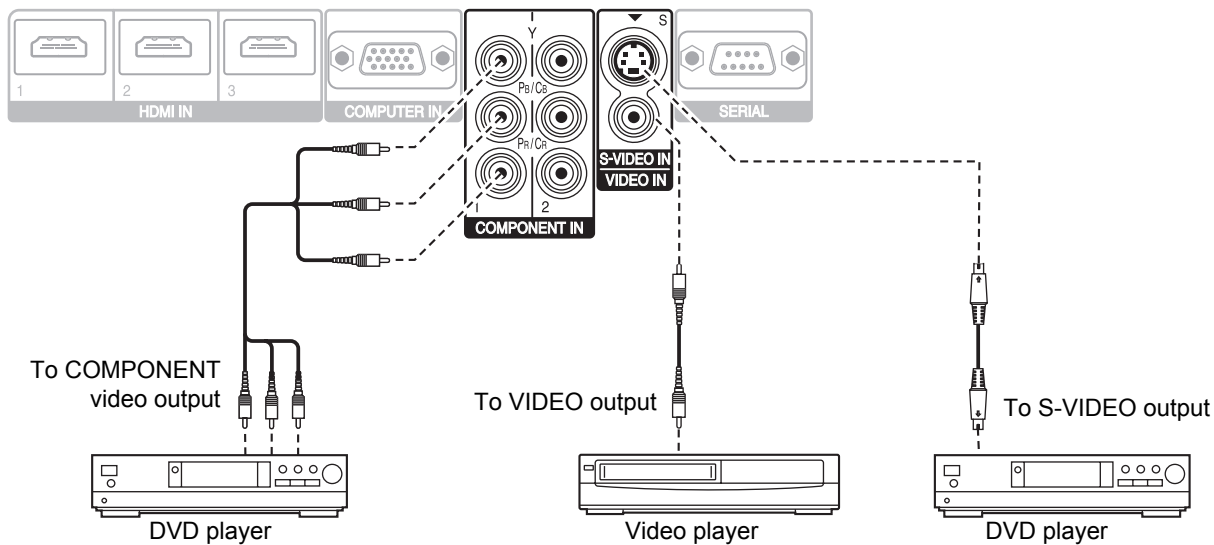

## Connecting example: HDMI IN/COMPUTER IN

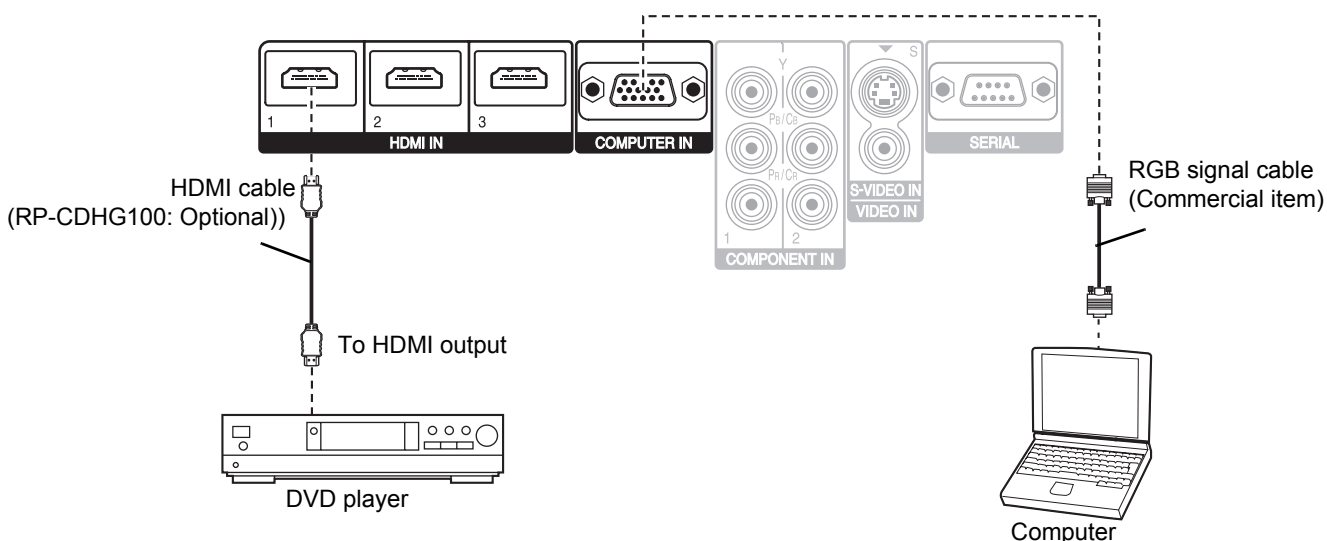

### NOTE:

- Make sure the HDMI cable is adapted to your HDMI device for proper performance.
- A compatible cable is required for an HDMI 1 080p signal.
- It is possible to connect with DVI devices via a HDMI/DVI conversion adapter, but some equipment may not project the image properly or other problems could be encountered. See “Serial terminal” on page 51.

# Switching the projector on/off

## Mains lead

### Connecting

1. Make sure the shape of the mains plug and the **AC IN** terminal on the back of the projector match, then push the plug all the way in.

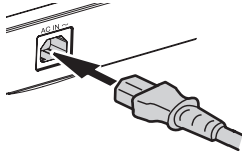

2. Align the side of the power cord secure lock with the side guide rail of the **AC IN** terminal of the projector and slide it in.

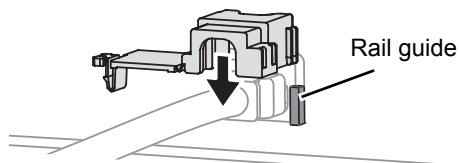

3. Place the latch to the latch catcher and press until it clicks.

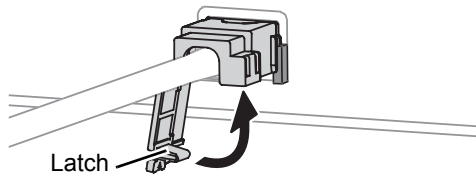

4. Connect the mains lead to a mains socket.

### Disconnecting

1. Unplug the mains lead from the mains socket.
2. Depress the latch and slide the cover off.

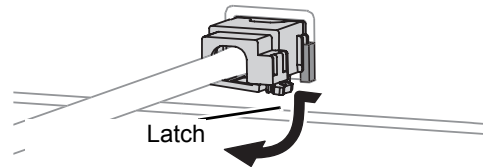

3. Slide the power cord secure lock up along the side guide rail and remove.

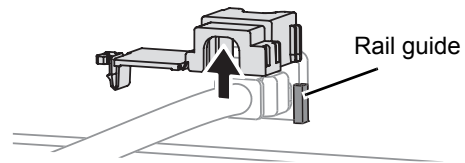

4. Hold the plug and unplug the mains lead from the **AC IN** terminal on the back of the projector.

### NOTE:

- Do not use other than the provided mains lead.
- Ensure all the input devices are connected and turned off before connecting the mains lead.
- Do not force the connector as this may damage the projector and/or the mains lead.
- Dirt or dust build-up around plugs may cause fire or electrical hazards.
- Switch off the power to the projector when not in use.

## Switching the projector on/off

### Power indicator

Power indicator informs you the status of the power.

- When the **TEMP** indicator is flashing, the power indicator will not light.

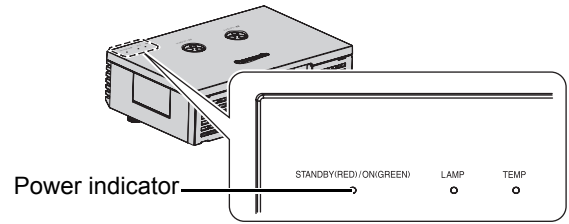

Indicator status		Status
No illumination or flashing		The <b>MAIN POWER</b> button is switched off.
Red	Lit	The <b>MAIN POWER</b> button is switched on and the projector is in standby mode.
Green	Flashing	The power button is switched on and the projector is getting ready to project.
	Lit	Projecting.
Orange	Lit	The power button is switched off and the projector is cooling the lamp.
	Flashing	The power button is switched on again when cooling the lamp and recovering to projection mode. Recovery may take a while.

#### NOTE:

- See "TEMP indicator" on page 45.
- While the projector is cooling the lamp, do not switch the **MAIN POWER** button off or unplug the mains lead.
- The electric consumption in standby mode is 0.08 W.

## Switching on the projector

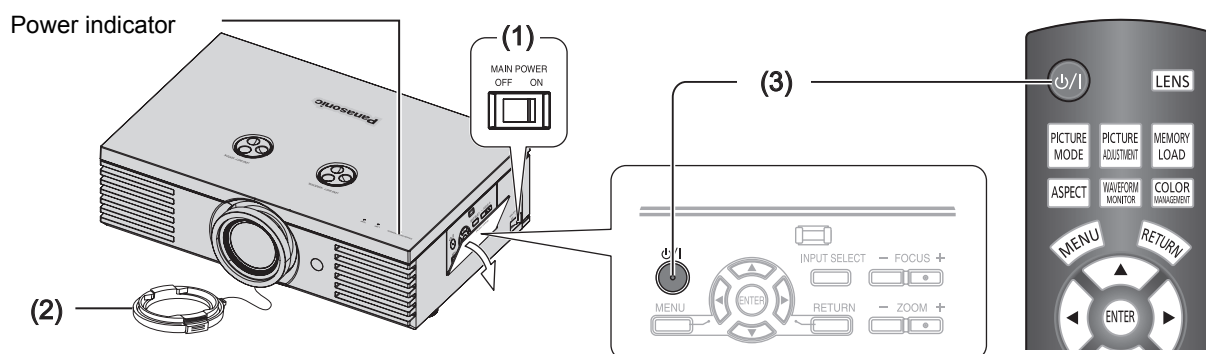

1. Remove the lens cover from the lens.
2. Switch the **MAIN POWER** button on.
  - The power indicator lights up in red.
3. Press the power button.
  - The power indicator lights up in green after flashing for a while.
  - The **STARTUP LOGO** is displayed on the screen. See "STARTUP LOGO" on page 43.

### NOTE:

- When the internal cooling fan is operating, some operational sound may be heard. The loudness of the operational sound depends on the external temperature.
- You can reduce the operational sound by setting the **LAMP POWER** in **OPTION** menu to the **ECO-MODE**. See "LAMP POWER" on page 44.
- When starting up the projector, some small rattling or tinkling sound may be heard, or the display may flicker for the characteristics of the lamp. Those are normal and will not affect the performance of the projector.
- Do not attempt to modify the lens cover which may cause burns, fire or damage to the projector.

## Switching off the projector

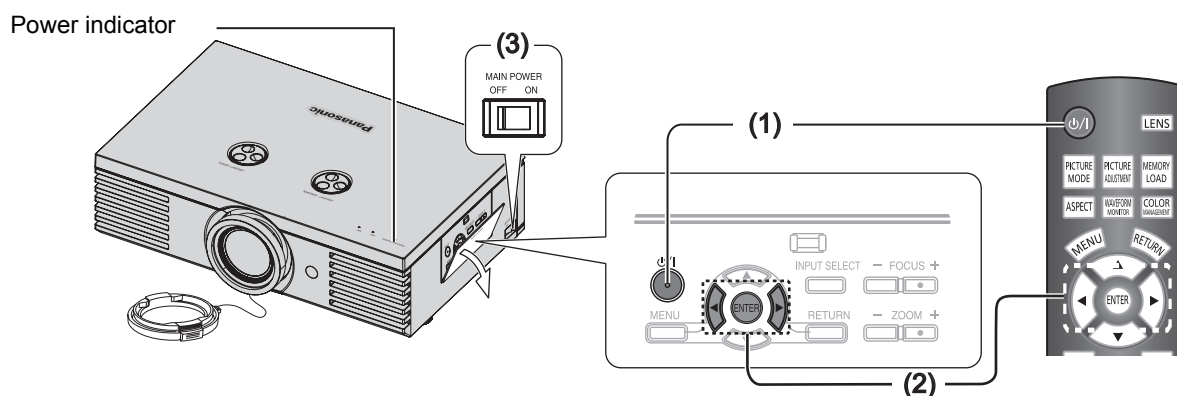

1. Press the power button.
  - The confirmation screen is displayed. It will disappear and return to the projection after 10 seconds without any operation.
  - To return to the projection, press any button except the power button.
2. Press ◀ to select **OK** and press the power or **ENTER** button.
  - The power indicator lights up in orange while cooling the lamp, then illuminates red when it is ready to switch off the **MAIN POWER** button.
3. Switch off the **MAIN POWER** button on the back of the projector.
4. Attach the lens cover.

### NOTE:

- Press the power button twice or for a long duration to switch the power off.

# Projecting an image

## Selecting the input signal

1. Switch on the connected devices.
  - Press the play button of the required device.
2. Press the **INPUT SELECT** button to select the required input method if needed. See “Switching the input signal” on page 28.
  - The image will be projected on the screen.

### NOTE:

- **AUTO SEARCH** is **ON** as default and the signal from the connected devices is detected automatically. See “AUTO SEARCH” on page 43.

## Positioning the image

1. Press the **ASPECT** button to select the required aspect mode. See “Switching the aspect ratio” on page 24.
2. Adjust the projected image with the lens shift dials.  
See “Lens shift and positioning” on page 16.
4. Adjust the focus and the projected image size.
  - Press +/- of the **FOCUS** and **ZOOM** buttons to adjust.
  - Press the **LENS** button to adjust the focus and zoom by the remote control. See “LENS CONTROL” on page 40.

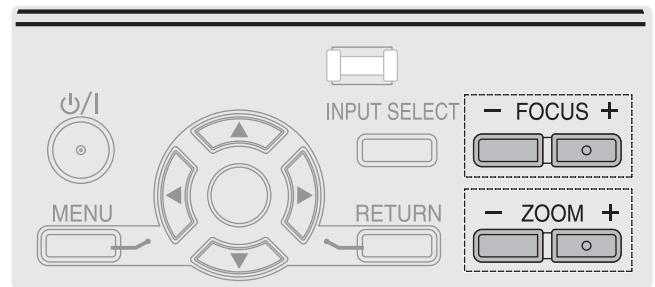
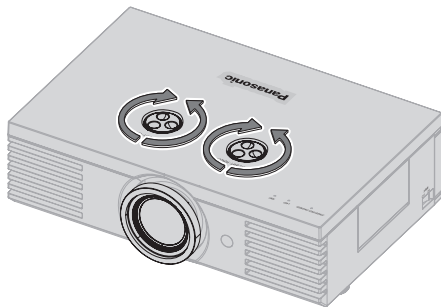

3. Adjust the angle of the projector.
  - Screw down the front leg adjusters and adjust the angle vertically.
  - See “Front leg adjusters and throwing angle” on page 15.

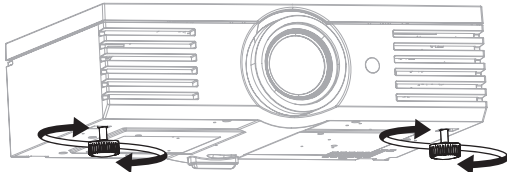

### NOTE:

- Do not touch the air exhaust port as this may cause burns or injury.
- If keystone distortion occurs, see “KEYSTONE” on page 39.
- If you adjust the focus, you may need to adjust the size of the image by pressing the **ZOOM** button again.

# Remote control operation

## Operating range

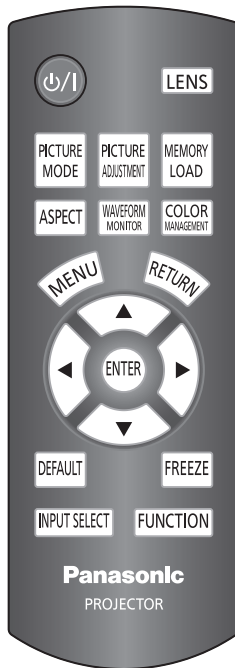

You can operate the projector with the remote control within the remote range 7 m (22'11").

### ● Facing to the projector

Ensure the remote control emitter is facing to the remote control signal receptor on front/back of the projector and press the required buttons to operate.

### ● Facing to the screen

Ensure the remote control emitter is facing to the screen and press the required buttons to operate the projector. The signal will be reflected off the screen. The operating range may differ due to the screen material. This function may not be effective with a translucent screen.

#### NOTE:

- Do not let strong light shine onto the signal receptor. The remote control may malfunction under strong light such as fluorescent.
- If there are any obstacles between the remote control and the remote control signal receptor, the remote control may not operate correctly.

## Managing the lens control settings

### LENS

You can adjust the focus and zoom of the projected image, and save the settings. Press

the **LENS** button to display the **LENS CONTROL** menu. See "LENS CONTROL" on page 40.

## Switching the picture mode

### PICTURE MODE

You can switch the preset picture mode settings by pressing the **PICTURE MODE** button. Press the button until the required setting is selected. See "PICTURE MODE" on page 32.

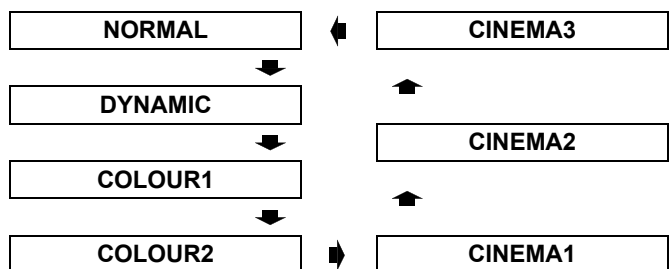

## Adjusting the image

### PICTURE ADJUSTMENT

You can display the **PICTURE** and **ADVANCED MENU** menu items in called up style by pressing the **PICTURE ADJUSTMENT** button. Press the button to switch between **PICTURE** and **ADVANCED MENU** menu. Press **▲ ▼** to select the required menu item and **◀ ▶** to adjust.

### ● PICTURE menu items

**PICTURE MODE, CONTRAST, BRIGHTNESS, COLOUR, TINT, SHARPNESS, COLOUR TEMPERATURE and DYNAMIC IRIS**

### ● ADVANCED MENU items

**GAMMA, CONTRAST, BRIGHTNESS, x.v.Colour, FRAME CREATION, DETAIL CLARITY, NR, MPEG NR, CINEMA REALITY and TV-SYSTEM**

#### NOTE:

- For each menu items description, see "PICTURE menu" on page 32.
- The screen will be cleared after 7 seconds without any operation.

## Remote control operation

### Loading a saved setting

MEMORY  
LOAD

You can access saved settings instantly. See “MEMORY LOAD” on page 36.

1. Select the required setting from **MEMORY1 - 16**.
  - Undefined setting will not be displayed.
2. Press the **ENTER** button to activate the selected setting.

**NOTE:**

- If you have not saved any settings, **MEMORY1 - 16** will not be displayed.

### Switching the aspect ratio

ASPECT

The aspect ratio will be selected automatically, or you can switch it manually by pressing the **ASPECT** button. Press the button several times to cycle through the different aspect type as follows. See “ASPECT” on page 37.

#### ● VIDEO/S-VIDEO/COMPONENT (YPbPr)

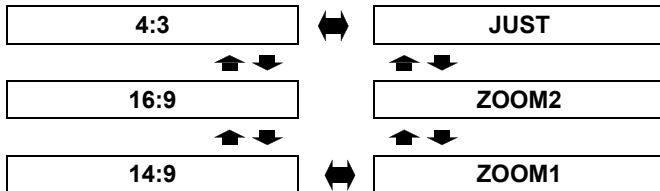

#### ● COMPUTER (RGB)



#### ● HDMI



**NOTE:**

- If you project an image with an unmatched aspect ratio, the image may distort or some portions may be cropped. Select an aspect ratio which preserves the intention of the image creator.
- The order of aspect type is defined not only by the input method but also by the input signals. See “List of compatible signals” on page 50.
- If you project a copyrighted image enlarged or distorted by using **ASPECT** function in commercial use in a public place, such as a restaurant or hotel, you might infringe on the copyright of the creator which is protected by copyright law.

### Adjusting the signal condition with a waveform

WAVEFORM  
MONITOR

You can display the image brightness and contrast level of the input signal with a waveform. See “WAVEFORM MONITOR” on page 33.

<b>FULL SCAN</b>	Monitoring the waveform of brightness and contrast of the whole image.
<b>SINGLE LINE SCAN</b>	Monitoring the waveform of brightness and contrast in each horizontal line of the image.

2. Press **ENTER** button until the required waveform option is displayed.
  - In **FULL SCAN** mode, press ▲ ▼ ◀ ▶ to change the waveform position.
  - In **SINGLE LINE SCAN** mode, press ▲ ▼ to select the required line position.

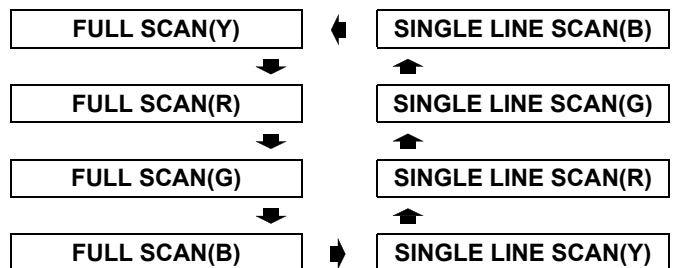

#### ■ Displaying the waveform

1. Press the **WAVEFORM** button and display the waveform monitor.
  - Press the **WAVEFORM** button again to escape from the waveform mode.

**NOTE:**

- In **SINGLE LINE SCAN** mode, the position of the waveform monitor depends on the position of the selected line.
- You can display the main menu by pressing the **MENU** button and adjust the menu items.
- The called up menu items displayed position depends on the position of the waveform monitor.
- You can activate **AUTO ADJUST** of the **WAVEFORM** menu by pressing the **DEFAULT** button.
- The signal which is lower than 0% in the waveform will be displayed as same as 0% on the projected image.
- While the waveform is displayed, the image is displayed without the **COLOUR MANAGEMENT** adjustment.
- When adjusting the **KEYSTONE** of the **POSITION** menu while the waveform is displayed, **x.v.Colour** will be deactivated.



## Adjustment example

Project a commercial test signal for picture adjustment on the screen and press the **WAVEFORM** button.

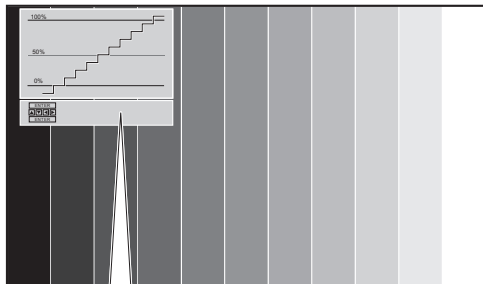

Adjust to 100%

Adjust to 0%      Monitor position

- With **COMPUTER** (except 1080) or **HDMI** (Expand)

Adjust to 100%

Adjust to 0%      Monitor position

## Adjusting with luminance options

1. Press the **ENTER** button several times to display **FULL SCAN(Y)/SINGLE LINE SCAN(Y)**.
  - In **SINGLE LINE SCAN** mode, select the required adjusting point by pressing **▲ ▼**.
2. Press the **PICTURE ADJUSTMENT** button and display the **BRIGHTNESS** by pressing **▲ ▼**.
  - When **ADVANCED MENU** is displayed, press the button again to switch to the **PICTURE** menu.

3. Adjust by pressing **◀ ▶**.
  - Adjust the bottom line of the waveform to 0 % (0 or 7.5 IRE).
  - Setting range: -32 to +32
4. Press **▲ ▼** to display the **CONTRAST**.
5. Adjust by pressing **◀ ▶**.
  - Adjust the up line of the waveform to 100 % (100 IRE).
  - Setting range: -64 to +64

### FULL SCAN(Y)/SINGLE LINE SCAN(Y)

<b>BRIGHTNESS</b>	Adjust the bottom line of the waveform to 0 % (0 or 7.5 IRE)
<b>CONTRAST</b>	Adjust the top line of the waveform to 100 % (100 IRE)

## Adjusting with RGB options

1. Press the **ENTER** button several times to display the required R/G/B waveform option.
  - In **SINGLE LINE SCAN** mode, select the required adjusting point by pressing **▲ ▼**.
2. Press the **PICTURE ADJUSTMENT** button and display the **BRIGHTNESS R/BRIGHTNESS G/BRIGHTNESS B** by pressing **▲ ▼**.
  - When **PICTURE** menu is displayed, press the button again to switch to the **ADVANCED MENU**.
3. Adjust by pressing **◀ ▶**.
  - Adjust the bottom line of the waveform to 0 % (0 or 7.5 IRE).
  - Setting range: -16 to +16
4. Press **▲ ▼** to display the **CONTRAST R/CONTRAST G/CONTRAST B**.
5. Adjust by pressing **◀ ▶**.
  - Adjust the up line of the waveform to 100 % (100 IRE).
  - Setting range: -32 to +32

### FULL SCAN(R)/SINGLE LINE SCAN(R)

<b>BRIGHTNESS R</b>	Adjust the bottom line of the waveform to 0 % (0 or 7.5 IRE)
<b>CONTRAST R</b>	Adjust the top line of the waveform to 100 % (100 IRE)

### FULL SCAN(G)/SINGLE LINE SCAN(G)

<b>BRIGHTNESS G</b>	Adjust the bottom line of the waveform to 0 % (0 or 7.5 IRE)
<b>CONTRAST G</b>	Adjust the top line of the waveform to 100 % (100 IRE)

### FULL SCAN(B)/

<b>BRIGHTNESS B</b>	Adjust the bottom line of the waveform to 0 % (0 or 7.5 IRE)
<b>CONTRAST B</b>	Adjust the top line of the waveform to 100 % (100 IRE)

## Setting your own colour profile

COLOR MANAGEMENT

You can adjust a selected colour individually and save and retrieve under the **PICTURE MODE** setting. Press the **COLOUR MANAGEMENT** button to open the menu. See "COLOUR MANAGEMENT" on page 35.

PROFILE	◀ NORMAL ▶
CURSOR	
LOG	
PROFILE SAVE	
PROFILE DELETE	
PROFILE NAME CHANGE	

### Create a new profile

#### ● Adjusting the selected colour

Select a colour and adjust **COLOUR**, **TINT** and **BRIGHTNESS**.

1. Select the **CURSOR** menu and press **ENTER**.
  - The projected image is captured, and the target cursor is displayed.
  - When the **LOG** is fully stored, the target cursor will not be displayed.

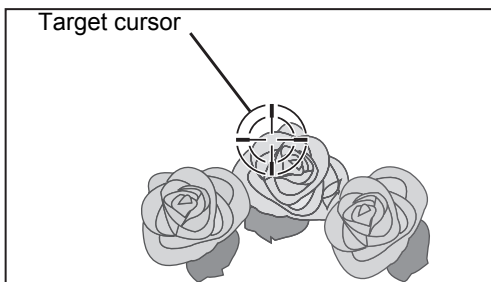

2. Move the cursor with **▲ ▼ ◀ ▶** to the required place to select a colour and press **ENTER**.
  - The colour at the centre of the target cursor is sampled and the sample box is displayed on the left of the cursor. The menu items are displayed on the upper part of the screen.

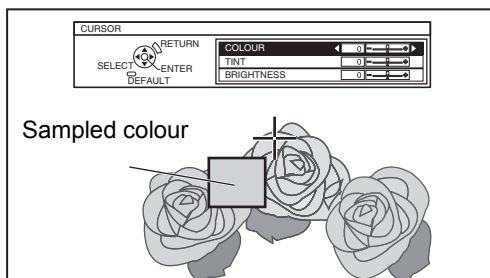

3. Select a menu item and the **◀ ▶** to adjust each item level.
  - The result box is displayed on the right of the cursor and shows the adjusted colour.

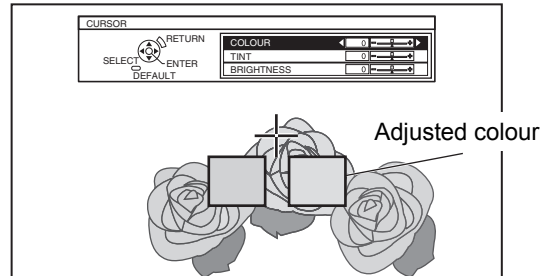

<b>COLOUR</b>	Adjust the vividness of the colour. Setting range: -30 to +30
<b>TINT</b>	Adjust the colour tone. Setting range: -30 to +30
<b>BRIGHTNESS</b>	Adjust the brightness of the colour. Setting range: -20 to +20

4. Press **ENTER** to store the adjusted result.
  - "PROCESSING" is displayed for a few seconds and the result is stored in **LOG**.
  - You can store up to 8 logs under **LOG** for each **PICTURE MODE** setting.
5. Press **MENU** or **RETURN** to return to the previous menu.
  - Repeat the steps above to store more adjustment.

#### ● Managing stored logs

You can edit or delete the stored logs of the selected **PICTURE MODE**.

1. Select **LOG** and press **ENTER**.
  - The **LOG** menu is displayed.

PICTURE MODE : CINEMA1			
POINT1	0	0	+2
POINT2	-1	0	-2
POINT3	0	+10	0
POINT4	-10	+10	-10
POINT5	-6	+5	+7
POINT6	+3	-3	+1
POINT7	0	+7	+9
POINT8	-1	+14	-4
ALL DELETE			

Sampled colour  Adjusted colour 

2. Select the required log from 1 - 8 or **ALL DELETE**, and press **ENTER**.
  - Select **CHANGE** to edit the log.  
The cursor menu is displayed and you can readjust the colour.
  - Select **DELETE** to delete the log.  
The confirmation screen will be displayed. Select **OK** to delete.
  - When you select **ALL DELETE**, the "DELETE ALL LOG." screen is displayed. Select **OK** to delete all logs. The **PROFILE** setting will be set to **NORMAL**.

## ● Saving a log setting as a profile

Return to the **COLOUR MANAGEMENT** menu and save the stored log as a profile. Make sure that the **PICTURE MODE** is not switched.

1. Select the **PROFILE SAVE** menu and press the **ENTER** button.
  - The **PROFILE SAVE** menu is displayed. You can save the profile as **USER1**, **USER2** and **USER3**.

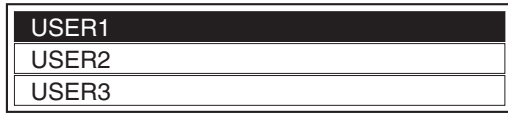

2. Press the **ENTER** button to save the profile.
  - The confirmation screen is displayed. Press **ENTER** again to save.
3. Name the profile.
  - Use **▲ ▼ ◀ ▶** to specify the location of the required character to enter and press the **ENTER** button.
  - You can enter up to 14 characters.

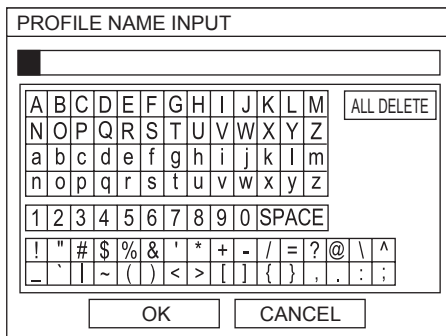

4. Repeat step 3 until you finish the text line.
  - Move cursor to **ALL DELETE** and press the **ENTER** button to delete all the entered text line.
  - Press the **DEFAULT** button to delete the last entered character or indicated with cursor in the text box.
  - To insert a character in the entered text line, move the cursor to the text box to select the required place and press **▼** then perform step 3.
5. Select **OK** and press the **ENTER** button to set the entered text as a name.
  - Press the **ENTER** button without entering any text to keep the default name.

## ● Deleting the saved profiles

You can delete the profiles from **PROFILE DELETE** menu.

1. Select **PROFILE DELETE** and press the **ENTER** button.
2. Select the required profile or **ALL DELETE** and press the **ENTER** button.
  - The confirmation screen will be displayed and select **OK**.
3. Press the **ENTER** button.

## ● Changing the profile names

You can change the name of the profiles from the **PROFILE NAME CHANGE** menu.

1. Select **PROFILE NAME CHANGE** and press the **ENTER** button.
2. Select the required profile and press the **ENTER** button.
3. Rename the profile.
  - Use **▲ ▼ ◀ ▶** to specify the location of the required character to enter and press the **ENTER** button.
4. Select **OK** and press the **ENTER** button to set the entered text as a name.

## ● Loading saved profiles

When profiles are loaded under the **PICTURE MODE** setting, you can keep them as you defined until the **PROFILE** is set to **NORMAL**.

1. Select the required **PICTURE MODE** and press the **ENTER** button.
2. Press the **COLOUR MANAGEMENT** button and select the **PROFILE** menu.
  - The profile settings of the selected **PICTURE MODE** will be displayed.
3. Select the required profile and press the **ENTER** button.

<b>NORMAL</b>	Return to the default setting of the <b>PICTURE MODE</b> menu.
<b>USER1</b>	
<b>USER2</b>	Defined profile settings.
<b>USER3</b>	

### NOTE:

- **LOG** and **PROFILE SAVE** are not displayed before you apply **COLOUR MANAGEMENT**.
- When the **LOG** is fully stored, the **CURSOR** will not be displayed.
- If you load a profile with a different attribute mode of the profile, the **CURSOR** and **PROFILE SAVE** menus will not be displayed.
- The approximate colours will be adjusted at the same time. If you adjust the exact same colour differently, both colours will affect each other and you might get unexpected results.
- White, Black and Grey are not adjustable.
- If you escape the **COLOUR MANAGEMENT** menu or attempt to perform another menu action before you save the adjusted profile, the confirmation screen will be displayed.
- If you switch the input signal before you save the profile, the setting will be cancelled without notice.
- When HDMI signal is selected, **COLOUR MANAGEMENT** is not available with the **COLOUR1** setting of the **PICTURE MODE**.

## Remote control operation

### Resetting to the factory default settings

**DEFAULT**

You can reset most of the customised settings to the factory defaults by pressing **DEFAULT** button of the remote control. Display the required sub-menu or the menu items and press the button again.

**NOTE:**

- Some menu items are not available to reset by pressing the **DEFAULT** button. Adjust each menu items manually.

### Capturing an image

**FREEZE**

Press the **FREEZE** button to capture the image, and you can see it as a still picture while the AV equipment are continuing. Press the **FREEZE** button again to escape and return to the continuing image.

While displaying the frozen image, you can enter the **AREA SELECT** mode of the **SPLIT ADJUST** menu by pressing the **ENTER** button. See "SPLIT ADJUST" on page 33.

### Switching the input signal

**INPUT SELECT**

You can switch the input method manually by pressing the **INPUT SELECT** button. Press the button several times or press ◀ ▶ to cycle through the input methods as follows. The actual projected image will be changed in a while.

- The graphical guidance will be displayed on the upper right of the projected image and you can confirm the selected input method which is highlighted in yellow. See "INPUT GUIDE" on page 43.

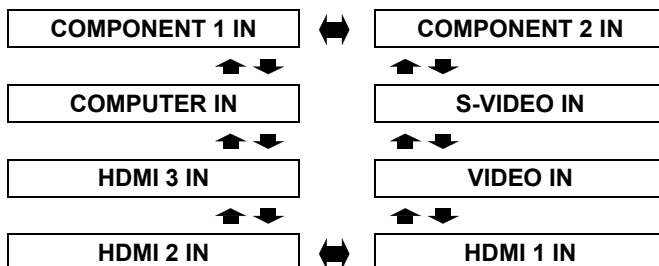

<b>COMPONENT 1 IN</b>	<b>COMPONENT</b> (YPBPR) signals from the equipment connected to <b>COMPONENT IN 1/COMPONENT IN 2</b> .
<b>COMPONENT 2 IN</b>	
<b>S-VIDEO IN</b>	<b>S-VIDEO</b> signal from the equipment connected to <b>S-VIDEO IN</b> .
<b>VIDEO IN</b>	<b>VIDEO</b> signal from the equipment connected to <b>VIDEO IN</b> .
<b>HDMI 1 IN</b>	<b>HDMI</b> signal from the equipment connected to <b>HDMI IN 1/HDMI IN 2/HDMI IN 3</b> .
<b>HDMI 2 IN</b>	
<b>HDMI 3 IN</b>	
<b>COMPUTER IN</b>	<b>COMPUTER</b> (RGB) signal from the equipment connected to <b>COMPUTER IN</b> .

**NOTE:**

- If you select an unplugged input method, the guidance will blink on and off several times.
- See "List of compatible signals" on page 50.
- See "Connections" on page 18.

### Using the assigned function as shortcut

You can access the assigned function in **FUNCTION BUTTON** menu as shortcut. See "FUNCTION BUTTON" on page 42.

HDMI 1 IN	page 28
HDMI 2 IN	
HDMI 3 IN	
COMPUTER IN	
COMPONENT 1 IN	
COMPONENT 2 IN	
S-VIDEO IN	
VIDEO IN	
BLANK	-
AUTO SETUP	page 39
CONTRAST	page 32
CONTRAST R	page 34
CONTRAST G	
CONTRAST B	

NORMAL	page 32
DYNAMIC	
COLOUR1	
COLOUR2	
CINEMA1	
CINEMA2	
CINEMA3	page 33
SPLIT ADJUST	
WAVEFORM AUTO ADJUST	page 40
LENS MEMORY LOAD	page 32
BRIGHTNESS	page 34
BRIGHTNESS R	
BRIGHTNESS G	
BRIGHTNESS B	

# Menu Navigation

## Navigating through the MENU

### Displaying the main menu



Press the **MENU** button to display the main menu and the operating guidance.

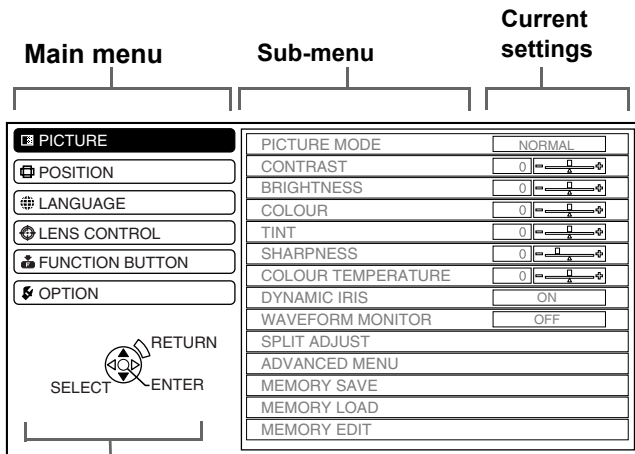

#### Operating guidance

Contains the required buttons to adjust the settings.

### Adjusting with the bar scale items

The triangle mark under the bar indicates factory default setting and the square indicates the current setting.

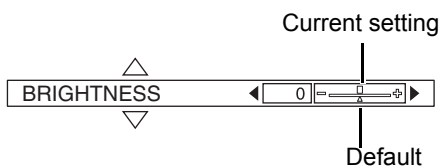

### Returning to the previous menu



Press the **MENU** or **RETURN** button to return to the previous menu. Press repeatedly to escape from the menu mode and return to the projection.

### Operating procedure

- Press **▲ ▼** to scroll to the required main menu item and press the **ENTER** button to select.
  - The selected item is highlighted in orange and the sub-menu is displayed on the right.
  - See "Main menu and sub-menu" on page 30.

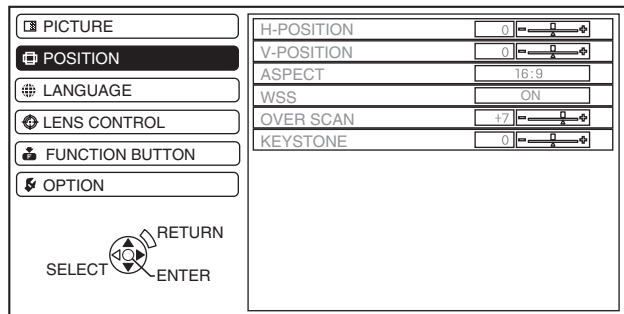

- Press **▲ ▼** to scroll to the required sub-menu item and press **◀ ▶** or the **ENTER** button to adjust.
  - The selected item is called up and the other menu items disappear from the screen. The Called up item will be disappear after 5 seconds and return to the menu mode.
  - If there is a lower level, the next level will be displayed.

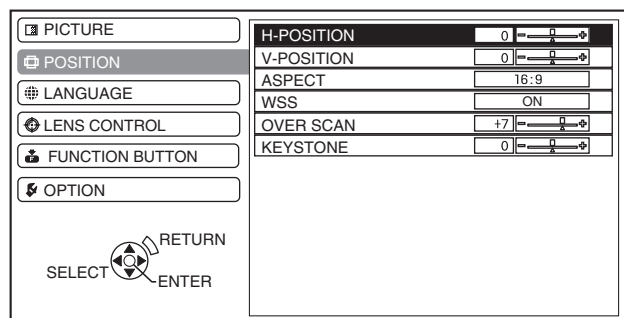

- Press **◀ ▶** to adjust or set the selected item.
  - For items using a bar scale, the current settings are displayed on the left of the bar scale.
  - You can cycle through the options of an item by pressing **◀ ▶**.

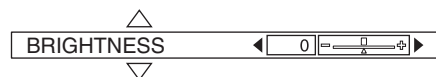

- Press the **MENU** or **RETURN** button to return to the previous menu.

#### NOTE:

- See "Resetting to the factory default settings" on page 28 to reset each menu items.

# Menu Navigation

## Main menu and sub-menu

The menu options are structured and categorised. You can navigate through the menu with ▲ ▼ ► ◀ buttons. See “Menu Navigation” on page 29.

### NOTE:

- The underlined items are factory default settings.
- Some default settings vary by the selected input signal.
- Sub-menu items vary according to the selected input signal.
- Some settings are adjustable without any signals.



## PICTURE

<b>PICTURE MODE</b>		page 32
NORMAL	DYNAMIC	
COLOUR1	COLOUR2	
CINEMA1	CINEMA2	
CINEMA3		
<b>CONTRAST</b>		page 32
(Default: 0)		
<b>BRIGHTNESS</b>		page 32
(Default: 0)		
<b>COLOUR</b>		page 32
(Default: 0)		
<b>TINT</b>		page 32
(Default: 0)		
<b>SHARPNESS</b>		page 32
(Default: 0)		
<b>COLOUR TEMPERATURE</b>		page 33
(Default: 0)		
<b>DYNAMIC IRIS</b>		page 33
<u>ON</u>	OFF	
<b>WAVEFORM MONITOR</b>		page 33
<u>OFF</u>		
FULL SCAN(Y)	FULL SCAN(R)	
FULL SCAN(G)	FULL SCAN(B)	
SINGLE LINE SCAN(Y)		
SINGLE LINE SCAN(R)		
SINGLE LINE SCAN(G)		
SINGLE LINE SCAN(B)		
MONITOR POSITION		
AUTO ADJUST		
<b>SPLIT ADJUST</b>		page 33
AREA SELECT	SPLIT ADJUST MODE	
NORMAL	REVERSE	
<b>ADVANCED MENU</b>		page 34
<b>GAMMA</b>		
GAMMA HIGH	(Default: 0)	
GAMMA MID	(Default: 0)	
GAMMA LOW	(Default: 0)	
<b>CONTRAST</b>		
CONTRAST R	(Default: 0)	
CONTRAST G	(Default: 0)	
CONTRAST B	(Default: 0)	
<b>BRIGHTNESS</b>		
BRIGHTNESS R	(Default: 0)	
BRIGHTNESS G	(Default: 0)	
BRIGHTNESS B	(Default: 0)	

## NR (Noise Reduction)

(Default: 0)

## MPEG NR

(Default: 0)

## FRAME CREATION

OFF MODE1 MODE2

## COLOUR MANAGEMENT

PROFILE CURSOR  
LOG PROFILE SAVE  
PROFILE DELETE PROFILE NAME CHANGE

## x.v.Colour

ON OFF

## DETAIL CLARITY

ON OFF

## CINEMA REALITY

ON OFF

## TV-SYSTEM

AUTO  
NTSC NTSC 4.43  
PAL PAL-M  
PAL-N SECAM

## MEMORY SAVE

MEMORY1 - 16 page 36

## MEMORY LOAD

MEMORY1 - 16 page 36

## MEMORY EDIT

MEMORY DEL MEMORY NAME CHANGE page 36

## SIGNAL MODE

page 36



## POSITION

### H - POSITION

(Default: 0) page 37

### V - POSITION

(Default: 0) page 37

### DOT CLOCK

(Default: 0) page 37

### CLOCK PHASE

(Default: 0) page 37

### ASPECT

4:3 16:9 14:9 ZOOM1  
ZOOM2 JUST

### WSS

page 39

<b>OVER SCAN</b> ▲	page 39
<b>KEystone</b> (Default: 0)	page 39
<b>AUTO SETUP</b>	page 39

 **LANGUAGE**

DEUTSCH	POLSKI
FRANÇAIS	ČEŠTINA
ESPAÑOL	MAGYAR
ITALIANO	РУССКИЙ
PORTUGUÊS	ไทย
SVENSKA	한국어
NORSK	ENGLISH
DANSK	中文

 **LENS CONTROL**

<b>ZOOM/FOCUS</b>	page 40
<b>LENS MEMORY LOAD</b> LENS MEMORY 1 - 3	page 40
<b>LENS MEMORY SAVE</b> LENS MEMORY 1 - 3	page 40
<b>LENS MEMORY EDIT</b> LENS MEMORY DELETE LENS MEMORY NAME CHANGE	page 41
<b>H-AREA POSITION</b>	page 41
<b>V-AREA POSITION</b>	page 41

 **FUNCTION BUTTON**

<b>BUTTON</b>	page 42
<u>HDMI 1 IN</u>	HDMI 2 IN
HDMI 3 IN	COMPUTER IN
COMPONENT 1 IN	COMPONENT 2 IN
S-VIDEO IN	VIDEO IN
BLANK	AUTO SETUP
CONTRAST	CONTRAST R
CONTRAST G	CONTRAST B
NORMAL	DYNAMIC
COLOUR1	COLOUR2
CINEMA1	CINEMA2
CINEMA3	SPLIT ADJUST
WAVEFORM AUTO ADJUST	
LENS MEMORY LOAD	
BRIGHTNESS	BRIGHTNESS R
BRIGHTNESS G	BRIGHTNESS B

 **OPTION**

<b>INPUT GUIDE</b>	page 43
<u>DETAILED</u> OFF	SIMPLE
<b>OSD DESIGN</b>	page 43
<u>TYPE1</u> TYPE3	TYPE2
<b>OSD POSITION</b>	page 43
UPPER LEFT UPPER RIGHT LOWER LEFT LOWER RIGHT	UPPER CENTRE <u>CENTRE</u> LOWER CENTRE
<b>BACK COLOUR</b>	page 43
<u>BLUE</u>	BLACK
<b>STARTUP LOGO</b>	page 43
<u>ON</u>	OFF
<b>AUTO SEARCH</b>	page 43
<u>ON</u>	OFF
<b>HDMI SIGNAL LEVEL</b>	page 43
<u>NORMAL</u>	EXPAND
<b>FRAME RESPONSE</b>	page 43
<u>NORMAL</u>	FAST
<b>INSTALLATION</b>	page 44
<u>FRONT/DESK</u> REAR/DESK	FRONT/CEILING REAR/CEILING
<b>SLEEP</b>	page 44
<u>OFF</u> 15 MIN.    20 MIN.    25 MIN.    30 MIN. 35 MIN.    40 MIN.    45 MIN.    50 MIN. 55 MIN.    60 MIN.	
<b>HIGH ALTITUDE MODE</b>	page 44
<u>OFF</u>	ON
<b>LAMP POWER</b>	page 44
<u>NORMAL</u>	ECO-MODE
<b>LAMP RUNTIME</b>	page 44

# PICTURE menu

## Remote control

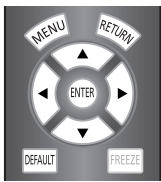

## Control panel

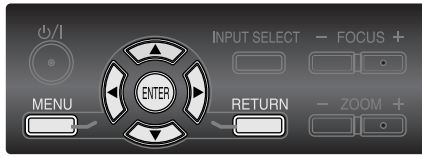

- See “Navigating through the MENU” on page 29.
- See “Main menu and sub-menu” on page 30.

## PICTURE MODE

Depending on the projection environment, you can use these preset parameter settings to optimise image projection. Press ◀ ▶ to cycle through the options.

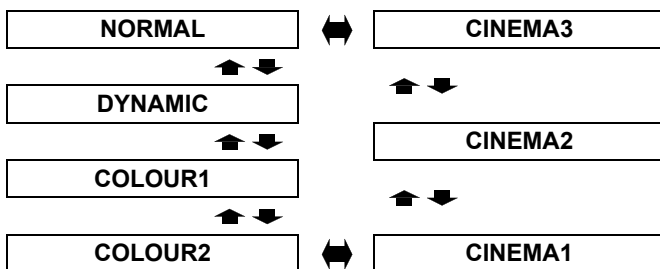

<b>NORMAL</b>	Setting for a general image, such as sports programme or TV games
<b>DYNAMIC</b>	Bright and sharp setting
<b>COLOUR1</b>	Setting for HDTV standard in ITU-R BT. 709 and colour temperature 6 500 K at the default setting of the <b>PICTURE</b> menu items.
<b>COLOUR2</b>	Setting for DCDM standard (SMPTE431-2) and colour temperature 6 300 K at the default setting of the <b>PICTURE</b> menu items.
<b>CINEMA1</b>	Setting tuned by top Hollywood colourists
<b>CINEMA2</b>	Deeper and more rich colour setting
<b>CINEMA3</b>	Vivid and crisp colour setting

### NOTE:

- It may take for a while until the selected mode is stabilised.

## CONTRAST

You can adjust the contrast of the projected image. Adjust the **BRIGHTNESS** in advance if necessary.

Lower  Higher

- Setting range: -64 to +64

## BRIGHTNESS

You can adjust the brightness of the projected image.

Darker  Brighter

- Setting range: -32 to +32

## COLOUR

You can adjust the colour saturation of the projected image.

Lighter  Darker

- Setting range: -32 to +32
- When **COMPUTER** signal is connected, only available with the following signals.
 

1 125 (1 080)/60i	1 125 (1 080)/50i
1 125 (1 080)/60p	1 125 (1 080)/50p

## TINT

You can adjust the skin tone in the projected image.

More reddish  More greenish

- Setting range: -32 to +32
- When **COMPUTER** signal is connected, only available with the following signals.
 

1 125 (1 080)/60i	1 125 (1 080)/50i
1 125 (1 080)/60p	1 125 (1 080)/50p

## SHARPNESS

You can adjust the sharpness of the projected image.

Less sharp  More sharp

- Setting range will vary according to the selected input signal.



## COLOUR TEMPERATURE

You can adjust the white balance of the projected image.



- Setting range: -6 to +6

## DYNAMIC IRIS

You can switch automatic adjustment of the lamp and the lens iris on/off.

- **ON:** Automatic adjustment
- **OFF:** No adjustment

## WAVEFORM MONITOR

You can monitor whether or not the luminance level of the input signal is in the recommended range by displaying it in the waveform monitor. If the waveform is not in the range, adjust it for the best quality. See "Adjusting the signal condition with a waveform" on page 24.

● OFF
FULL SCAN(Y)
FULL SCAN(R)
FULL SCAN(G)
FULL SCAN(B)
SINGLE LINE SCAN(Y)
SINGLE LINE SCAN(R)
SINGLE LINE SCAN(G)
SINGLE LINE SCAN(B)
MONITOR POSITION ◀ UPPER LEFT ▶
AUTO ADJUST

1. Press ▲ ▼ to move to the required waveform style.
2. Press ENTER to select.
  - The **WAVEFORM MONITOR** will be displayed.
  - See "Adjusting the signal condition with a waveform" on page 24.

### NOTE:

- When the **WAVEFORM MONITOR** is set to **OFF**, the **AUTO ADJUST** is not displayed.
- The waveform of the **WAVEFORM MONITOR** will not be displayed correctly with a noisy equipment or source.
- The **WAVEFORM MONITOR** adjusts the signal level based on the reference signal which consist of 0% and 100%. The over scanned reference signal which runs off the edge of the screen, below 0% or over 100% signal level will not be adjusted correctly.

## MONITOR POSITION

When the **FULL SCAN** is selected, press ▲ ▼ ◀ ▶ to adjust the position of the monitor.

- See "Adjusting the signal condition with a waveform" on page 24.

## AUTO ADJUST

You can switch on/off the automatic adjustment system in each items.

<b>BLACK LEVEL ADJUST</b> Adjust the black level of luminance (Y) to 0%.	<b>ON</b>
<b>WHITE LEVEL ADJUST</b> Adjust the white level of luminance (Y) to 100%.	<b>ON</b>
<b>RGB ADJUST (BLACK)</b> Adjust the black level of colours (R/G/B) to 0%.	<b>OFF</b>
<b>RGB ADJUST (WHITE)</b> Adjust the white level of colours (R/G/B) to 100%.	<b>OFF</b>

1. Press ▲ ▼ and select the required item.
2. Press ◀ ▶ and switch on/off.
3. Press ▲ ▼ and select **AUTO** and press **ENTER**.
  - The confirmation screen will be displayed.
4. Press ◀ ▶ and select **OK**.
5. Press **ENTER**.

## SPLIT ADJUST

You can perform image adjustment for some **PICTURE** menu items while displaying a certain area of the frozen image in a split window.

### ● SPLIT ADJUST MODE

Select the required split style from **NORMAL** and **REVERSE** in the **SPLIT ADJUST MODE** menu.

- **NORMAL**

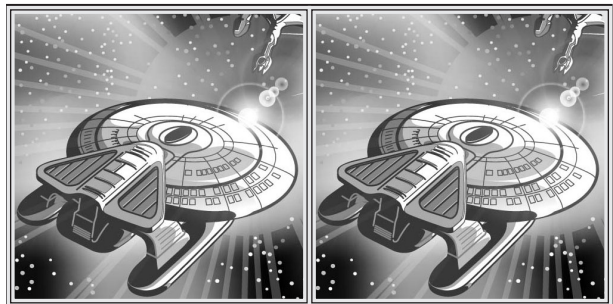

- **REVERSE**

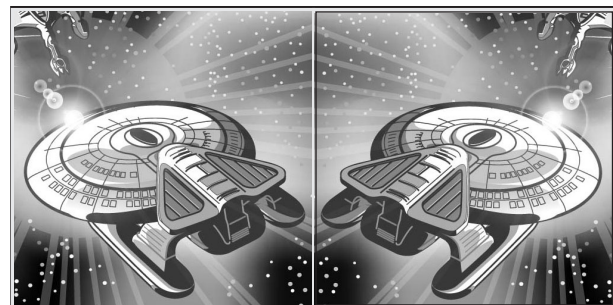

## PICTURE menu

### ● Adjusting the image in a split window

1. Select **AREA SELECT** and press the **ENTER** button.
  - The image will be frozen and the area cursor will be displayed.

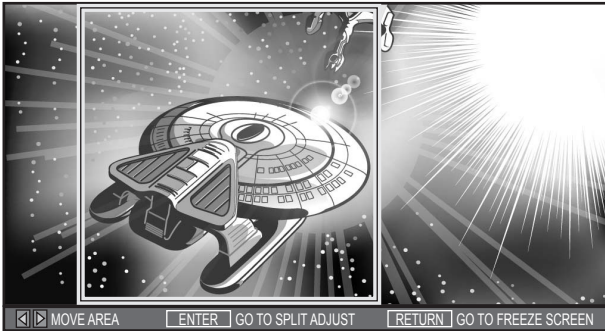

2. Press **◀▶** to move the area cursor to select the area of interest and press the **ENTER** button.
  - The selected frozen image will be displayed in a split window.
3. Press the **MENU** to display the **PICTURE** menu on the right.

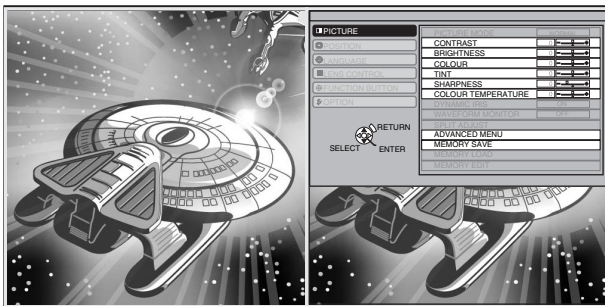

4. Adjust the required **PICTURE** menu items.
  - Only the highlighted menu items are adjustable.
  - Sub-menu items vary according to the selected input signal. See "Main menu and sub-menu" on page 30.
5. Press the **MENU/RETURN** button several times to escape from the menu.
6. Press the **ENTER** button.
  - The confirmation screen will be displayed. Select **OK** to finish the adjustment.
7. Press the **ENTER** button.
  - Press the **ENTER** button again to return to the **AREA SELECT**.
  - Press the **RETURN** button to escape from the **SPLIT ADJUST** mode.

## ADVANCED MENU

You can perform more detailed image adjustment manually.

### ■ GAMMA

You can adjust linear intensity at 3 levels. Press **◀▶** to increase/decrease 1 point.

Levels	Default setting
<b>GAMMA HIGH</b>	0
<b>GAMMA MID</b>	0
<b>GAMMA LOW</b>	0

- Setting range: -8 to +8

### ■ CONTRAST

You can adjust the amount of contrast of individual RGB colours. Press **◀▶** to increase/decrease 1 point.

RGB	Default setting
<b>CONTRAST R</b>	0
<b>CONTRAST G</b>	0
<b>CONTRAST B</b>	0

- Setting range: -32 to +32

### ■ BRIGHTNESS

You can adjust the brightness of individual RGB colours. Press **◀▶** to increase/decrease 1 point.

RGB	Default setting
<b>BRIGHTNESS R</b>	0
<b>BRIGHTNESS G</b>	0
<b>BRIGHTNESS B</b>	0

- Setting range: -16 to +16

### ■ NR (Noise Reduction)

You can adjust the automatic noise reduction system level. Press **◀▶** to change the level.

- Setting range: 0 to +3

## MPEG NR

You can adjust the automatic noise reduction system level for MPEG format images. The system minimise block noise and mosquito noise to eliminate jagged edges, providing an overall smoother image. Press ◀ ▶ to change the level.

- Setting range: 0 to +3

### NOTE:

- **MPEG NR** system is not available with **COMPUTER/HDMI (VGA60)** signals.

## FRAME CREATION

You can activate the rendering system for fast motion frames with fewer afterimage. Press ◀ ▶ to select the required option.

- **OFF** Deactivate
- **MODE1** Setting for a standard image
- **MODE2** Setting for a moving image

### NOTE:

- With some of the images, it might be difficult to see a difference in result.
- The image might look slower with the **MODE2** setting. When the result does not meet your requirement, select **MODE1** or deactivate the system.

## COLOUR MANAGEMENT

You can manage your own defined colour settings. See "Setting your own colour profile" on page 26.

## x.v.Colour

You can switch on/off the automatic adjustment system for signals which comply with xvYCC.

- **ON:** Active
- **OFF:** Deactive

### NOTE:

- **x.v.Colour** adjustment system is available only with **HDMI** signals in **COLOUR1** of **PICTURE MODE** menu.

## DETAIL CLARITY

You can switch the automatic detail clarity system on/off.

- **ON:** Active
- **OFF:** Deactive

## CINEMA REALITY

You can switch the automatic image synchroniser on/off for 24 frames a second images, such as movies. Press ◀ ▶ to select the required setting.

- **ON:** Active
- **OFF:** Deactive

### NOTE:

- **CINEMA REALITY** is effective only with interlace signals.

## TV-SYSTEM

When the video signal is changed, the setting switches automatically.

You can switch the setting manually to match the video data. Press ◀ ▶ to cycle through the options.

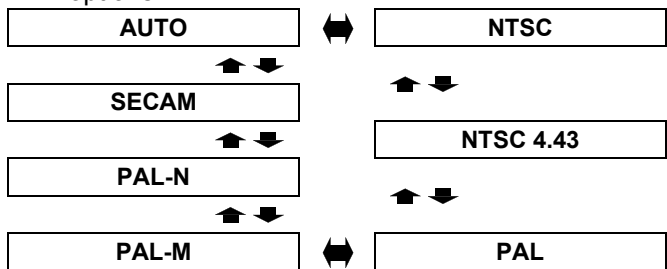

### NOTE:

- **AUTO** setting will select from **NTSC/NTSC 4.43/PAL/PAL60/PAL-M/PAL-N/SECAM**.

## PICTURE menu

### MEMORY SAVE

You can save and name the adjusted **PICTURE** menu settings for instant access from **MEMORY LOAD** menu.

1. Adjust the items in **PICTURE** menu.
2. Select **MEMORY SAVE** and press the **ENTER** button.
3. Select the required memory setting and press the **ENTER** button.
  - The confirmation screen will be displayed. Select **OK** and press the **ENTER** button.
  - Indicated with ★ is in use, and ☆ is empty.
4. Name the memory setting.
  - Use ▲ ▼ ◀ ▶ to specify the location of the required character to enter and press the **ENTER** button.
  - You can enter up to 16 characters.

MEMORY NAME INPUT

																ALL DELETE
A	B	C	D	E	F	G	H	I	J	K	L	M				ALL DELETE
N	O	P	Q	R	S	T	U	V	W	X	Y	Z				
a	b	c	d	e	f	g	h	i	j	k	l	m				
n	o	p	q	r	s	t	u	v	w	x	y	z				
1	2	3	4	5	6	7	8	9	0	SPACE						
!	"	#	\$	%	&	'	*	+	-	/	=	?@	\	^		
_	`		~	(	)	<	>	[	]	{	}	,	.	:	;	

OK CANCEL

5. Repeat step 4 until you finish the text line.
  - Move the cursor to **ALL DELETE** and press the **ENTER** button to delete all the entered text line.
  - Press the **DEFAULT** button to delete the last entered character or indicated with cursor in the text box.
  - To insert a character in the entered text line, move the cursor to the text box to select the required place and press ▼ then perform step 4.
6. Select **OK** and press the **ENTER** button to set the entered text as a name.

#### NOTE:

- If you leave the text box empty and save, the default memory number will stay as a name.

### MEMORY LOAD

You can access the saved settings instantly. See "Loading a saved setting" on page 24.

1. Select a setting from **MEMORY1 - 16**.
  - Undefined settings will not be selectable.
2. Press **ENTER** to activate.

#### NOTE:

- If you have not saved any settings, **MEMORY1 - 16** will not be displayed.

### MEMORY EDIT

You can edit the named memory settings.

#### ● Deleting a memory setting

1. Select **MEMORY DEL** and press the **ENTER** button.
2. Select the required memory setting and press the **ENTER** button.
  - If you select **ALL DELETE**, you can delete all of the saved memory settings.
3. Select **OK** in the confirmation screen and press the **ENTER** button.

#### ● Changing the name of the memory setting

1. Select the required memory setting and press the **ENTER** button.
2. Rename the memory setting.
  - Use ▲ ▼ ◀ ▶ to specify the location of the required character to enter and press the **ENTER** button.
  - You can enter up to 16 characters.

MEMORY NAME INPUT

																ALL DELETE
A	B	C	D	E	F	G	H	I	J	K	L	M				ALL DELETE
N	O	P	Q	R	S	T	U	V	W	X	Y	Z				
a	b	c	d	e	f	g	h	i	j	k	l	m				
n	o	p	q	r	s	t	u	v	w	x	y	z				
1	2	3	4	5	6	7	8	9	0	SPACE						
!	"	#	\$	%	&	'	*	+	-	/	=	?@	\	^		
_	`		~	(	)	<	>	[	]	{	}	,	.	:	;	

OK CANCEL

3. Repeat step 2 until you finish the text line.
  - Move the cursor to **ALL DELETE** and press the **ENTER** button to delete all the entered text line.
  - Press the **DEFAULT** button to delete the last entered character or indicated with cursor in the text box.
  - To insert a character in the entered text line, move the cursor to the text box to select the required place and press ▼ then perform step 2.
4. Select **OK** and press the **ENTER** button to set the entered text as a name.

#### NOTE:

- If you have not saved any settings, **MEMORY1 - 16** will not be displayed.

### SIGNAL MODE

The current selected signal will be displayed. This is available with signals from **COMPUTER IN/ COMPONENT IN/HDMI IN** only.

#### NOTE:

- See "List of compatible signals" on page 50.

# POSITION menu

**Remote control**

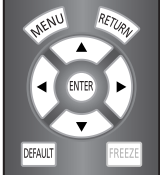

**Control panel**

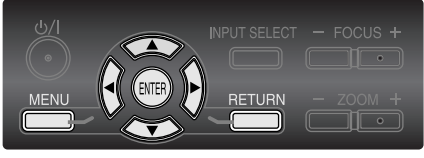

- See “Navigating through the MENU” on page 29.
- See “Main menu and sub-menu” on page 30.

## H-POSITION

You can move the projected image horizontally for fine adjustment.



## V-POSITION

You can move the projected image vertically for fine adjustment.



## DOT CLOCK

If you have interference patterns of the projected image, which is sometimes referred to as moire or noise, you can minimize it by pressing ◀ ▶ to adjust the clock frequency. (Available with signals from **COMPUTER IN** only)

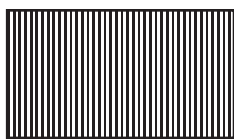

**NOTE:**

- If the projecting signal’s dot clock frequency is higher than 150 MHz, the adjustment may not make a difference.
- **DOT CLOCK** needs to be adjusted before adjusting the **CLOCK PHASE**.

## CLOCK PHASE

If you require further adjustment for the same reason as the **DOT CLOCK** adjustment, you can fine adjust the timing of the clock. Press ◀ ▶ to adjust. (Available with signals from **COMPUTER IN/COMPONENT IN** only)

**NOTE:**

- If the projecting signal’s dot clock frequency is higher than 150 MHz, the adjustment may not make a difference.
- Available signals from **COMPONENT IN**:  
1 125 (1 080)/60i, 1 125 (1 080)/50i, 1 125 (1 080)/60p,  
1 125 (1 080)/50p, 1 125 (1 080)/24p, 750 (720)/60p

## ASPECT

You can switch the aspect ratio manually when needed.

### Aspect ratio depend on signals

Press ◀ ▶ to cycle through the aspect ratio options. The cycle pattern depends on the connected signals.

<b>VIDEO/ S-VIDEO</b>	4:3 → 16:9 → 14:9 → ZOOM1 → ZOOM2 → JUST AUTO → 4:3 → 16:9 → JUST → ZOOM NTSC signal
<b>COMPUTER (RGB)</b>	4:3 → 16:9 4:3 → 16:9 VGA or SVGA signals Not switchable with WIDE480/600/720/768/768-2/800/900 signals
<b>HDMI</b>	4:3 → 16:9 16:9 → H - FIT → V - FIT → ZOOM 1 125 (1 080)/50i, 1 125 (1 080)/60i, 1 125 (1 080)/50p, 1 125 (1 080)/60p, 1 125 (1 080)/24p, 750 (720)/50p and 750 (720)/60p signals 4:3 → 16:9 → JUST → ZOOM 525p (480p) and 625p (576p) signals
<b>COMPONENT (YPBPR)</b>	4:3 → 16:9 → 14:9 → JUST → ZOOM1 → ZOOM2 625i (576i), 625p (576p) AUTO → 4:3 → 16:9 → JUST → ZOOM 525i (480i), 525p (480p) 16:9 → H - FIT → V - FIT 1 125 (1 080)/50i, 1 125 (1 080)/60i, 1 125 (1 080)/50p, 1 125 (1 080)/60p, 1 125 (1 080)/24p, 750 (720)/50p, 750 (720)/60p signals











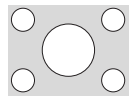
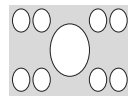
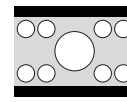
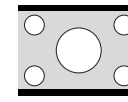
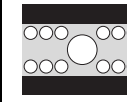
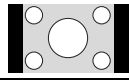
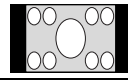
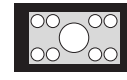
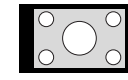
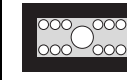

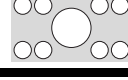
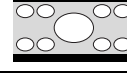
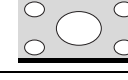
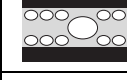

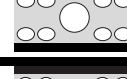

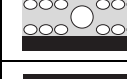

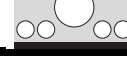

## POSITION menu

### ■ Aspect ratio options and projection example

If you apply the aspect ratio options to the projected image, the result will be as follows. The result may differ due to the input signals. See "Switching the aspect ratio" on page 24.







### ● VIDEO/S-VIDEO/COMPONENT

Not available with 1 125 (1 080)/50i, 1 125 (1 080)/60i, 1 125 (1 080)/50p, 1 125 (1 080)/60p, 1 125 (1 080)/24p, 750 (720)/50p and 750 (720)/60p signals.

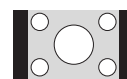
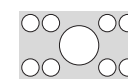
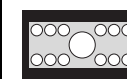
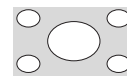
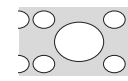
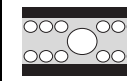
Original size		4:3	Squeeze signal	16:9 Letter box	14:9 Letter Box	2.35:1 Cinescope
						
4:3	Projects at 4:3.					
16:9	Adjusts horizontally to 16:9.					
JUST	Adjusts horizontally to fit 16:9. Closer to edge, more enlarged. Not available with <b>COMPUTER</b> signals.					
ZOOM/ ZOOM1	Adjusts to 16:9 size while preserving original ratio. Escape the menu mode and press ▲▼ to adjust vertically.					
ZOOM2	Adjusts to cinescope size not including letter box. Escape the menu mode and press ▲▼ to adjust vertically.					
14:9	Adjusts to 14:9.					

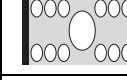
### ● COMPONENT signals

Available with 1 125 (1 080)/50i, 1 125 (1 080)/60i, 1 125 (1 080)/50p, 1 125 (1 080)/60p, 1 125 (1 080)/24p, 750 (720)/50p and 750 (720)/60p signals

Original Size		4:3	16:9	Cinescope
				
H - FIT	Adjusts horizontally to 16:9.			
V - FIT	Adjusts to 16:9 vertically. Escape and press ▲▼ to scroll the image to adjust the edge vertically.			
ZOOM	Adjusts to 16:9 size with preserving original ratio. Escape the menu mode and press ▲▼ to adjust vertically.			

## WSS

**WSS** (Wide Screen Signalling) detects if a **PAL/625p (576p)/625i (576i)** signal is input and that signal has an identification signal, and switch the aspect ratio to required setting automatically. You can switch the system off manually.

## OVER SCAN





If the 4 edges of an image is partly dropped, you can use this function to adjust and project it properly.

- Setting range: 0 to +10
- **OVER SCAN** is not available with **COMPUTER** signals.

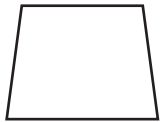

## KEYSTONE

If the projector is aligned non-perpendicularly to the screen, or if the projection screen has an angled surface, you can correct the keystone vertically.

Image	Operation
	
	

- Setting range: -32 to 32

### NOTE:

- You can correct the distortion  $\pm 30$  degrees from the vertical plane. For a better quality image, installing the projector with minimum distortion is recommended.
- Some distortion may be retained for the lens shift adjustment.
- The distortion of the main menu screen is not correctable.
- The result of the keystone correction will affect the aspect ratio and the size of the image.

## AUTO SETUP

You can adjust **V - POSITION**, **H - POSITION**, **DOT CLOCK** and **CLOCK PHASE** automatically when connecting via **COMPUTER IN**. Press **ENTER** to adjust these at the same time.

# LENS CONTROL

## Remote control

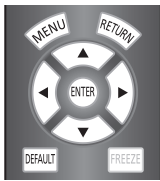

- See “Navigating through the MENU” on page 29.
- See “Main menu and sub-menu” on page 30.

## Control panel

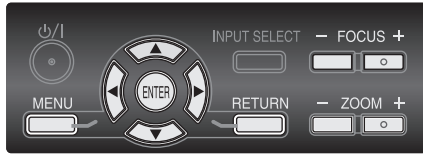

### NOTE:

- The saved lens memory adjustment accuracy is not guaranteed.
- If the memorised **ZOOM/FOCUS** adjustment is not accurate enough, adjust the **ZOOM/FOCUS** menu again.

## ZOOM/FOCUS

You can use the 2 different test patterns to adjust the focus and zoom of the image. See “Lens shift and positioning” on page 16.

1. Press **ENTER** to display test pattern 1.
  - Press **▲ ▼** to adjust the focus and **◀ ▶** to adjust the zoom.

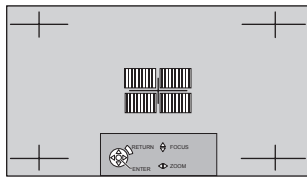

2. Press **ENTER** to display test pattern 2.
  - Press **▲ ▼** to adjust the focus and **◀ ▶** to adjust the zoom.

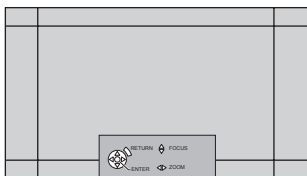

3. Press **ENTER** to display the projected image.
  - You can confirm the adjustment is fit to the projected image.
4. Press **MENU** or **RETURN** to return to the previous menu, or press repeatedly to escape the menu mode.

### NOTE:

- When the projector and/or the screen is tilted, adjust the focus at the centre of the image. The upper and lower edge might be out of focus.
- When the image is distorted in keystone, adjust the **KEystone** in **POSITION** menu.

## LENS MEMORY LOAD

You can access the saved lens control settings instantly.

1. Select a setting from **LENS MEMORY 1 - 3**.
2. Press the **ENTER** button to activate.

### NOTE:

- The option that contains no saved adjustment will not be displayed.
- If there is no saved setting, the **LENS MEMORY LOAD** menu will not be selectable.

## LENS MEMORY SAVE

You can save and name the adjusted **ZOOM/FOCUS**, **H-AREA POSITION** and **V-AREA POSITION** settings in memory.

1. Adjust **ZOOM/FOCUS**, **H-AREA POSITION** and **V-AREA POSITION**.
2. Select the **LENS MEMORY SAVE** and press the **ENTER** button.
3. Select the required memory setting and press the **ENTER** button.
4. The confirmation screen will be displayed. Select **OK** and press the **ENTER** button.
  - Indicated with **★** is in use, and **☆** is empty.
5. Name the lens memory setting.
  - Use **▲ ▼ ◀ ▶** to specify the location of the required character to enter and press the **ENTER** button.

LENS MEMORY NAME INPUT

A	B	C	D	E	F	G	H	I	J	K	L	M	ALL DELETE		
N	O	P	Q	R	S	T	U	V	W	X	Y	Z			
a	b	c	d	e	f	g	h	i	j	k	l	m			
n	o	p	q	r	s	t	u	v	w	x	y	z			
1	2	3	4	5	6	7	8	9	0	SPACE					
!	"	#	\$	%	&	'	*	+	-	/	=	?@	\	^	
_	`	~	(	)	<	>	[	]	{	}	,	.	:	;	

OK
CANCEL

6. Repeat step 5 until you finish the text line.
  - You can enter up to 16 characters.
  - Move the cursor to **ALL DELETE** and press the **ENTER** button to delete all the entered text line.
  - Press the **DEFAULT** button to delete the last entered character or indicated with the cursor in the text box.
  - To insert a character in the entered text line, move the cursor to the text box to select the required place and press **▼** then perform step 5.
7. Select **OK** and press the **ENTER** button to set the entered text as a name.

### NOTE:

- If you leave the text box empty and save, the default memory number will stay as a name.



## LENS MEMORY EDIT

You can edit named lens memory settings.

### ● Deleting a memory setting

1. Select **LENS MEMORY DELETE** and press the **ENTER** button.
2. Select the required lens memory setting and press the **ENTER** button.
3. If you select **ALL DELETE**, you can delete all of the saved lens memory settings.
4. Select **OK** in the confirmation screen and press the **ENTER** button.

### ● Changing the name of the memory setting

1. Select the required lens memory setting and press the **ENTER** button.
2. Rename the lens memory setting.
  - Use ▲ ▼ ◀ ▶ to specify the location of the required character to enter and press the **ENTER** button.
3. Repeat step 2 until you finish the text line.
  - You can enter up to 16 characters.
  - Move the cursor to **ALL DELETE** and press the **ENTER** button to delete all the entered text line.
  - Press the **DEFAULT** button to delete the last entered character or indicated with the cursor in the text box.
  - To insert a character in the entered text line, move the cursor to the text box to select the required place and press ▼ then perform step 2.
4. Select **OK** and press the **ENTER** button to set the entered text as a name.

#### NOTE:

- The option that contains no saved adjustment will not be displayed
- If you leave the text box empty and save, the default memory name will stay as a name.

## H-AREA POSITION

You can move the frame area horizontally, such as aligning the right or left frame edge to the screen edge. Press ◀ ▶ to move the frame.

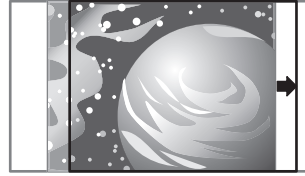

## V-AREA POSITION

You can move the frame area vertically, such as aligning the up or bottom frame edge to the screen edge. Press ▲ ▼ to move the frame.

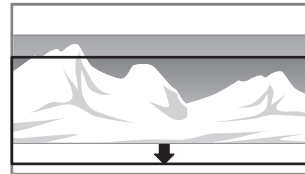

# FUNCTION BUTTON

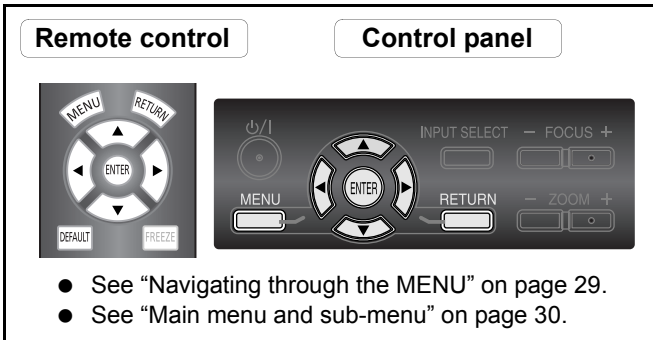

## BUTTON

You can assign certain menu option to the **FUNCTION** button as shortcut. Press ▲ ▼ ◀ ▶ to select the required menu options and press the **ENTER** button.

### ● **BLANK function**

You can stop the projection temporary for electrical power save while the input source is stopped. Press any button to escape from the blank mode.

### ● **Assignable functions**

Functions	Refer	
<u>HDMI 1 IN</u> *1	page 28	
HDMI 2 IN		
HDMI 3 IN		
COMPUTER IN		
COMPONENT 1 IN		
COMPONENT 2 IN		
S-VIDEO IN		
VIDEO IN		
BLANK		-
AUTO SETUP		page 39
CONTRAST	page 32	
CONTRAST R	page 34	
CONTRAST G		
CONTRAST B		
NORMAL	page 32	
DYNAMIC		
COLOUR1		
COLOUR2		
CINEMA1		
CINEMA2		
CINEMA3	page 33	
SPLIT ADJUST		
WAVEFORM AUTO ADJUST	page 40	
LENS MEMORY LOAD	page 32	
BRIGHTNESS	page 34	
BRIGHTNESS R		
BRIGHTNESS G		
BRIGHTNESS B		

\*1. The underlined item is factory default setting.

# OPTION menu

## Remote control

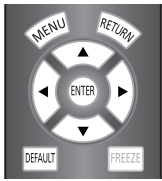

## Control panel

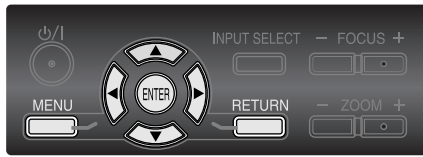

- See “Navigating through the MENU” on page 29.
- See “Main menu and sub-menu” on page 30.

## INPUT GUIDE

When you change the input method, the guidance appears in the upper right corner of the screen. The following display methods are available. Press ◀ ▶ to cycle through the options.

Options	Function
<b>DETAILED</b>	Display the input method graphically. The <b>INPUT GUIDE</b> will go out after 3 seconds without any operation.
<b>SIMPLE</b>	Display the input method by text. The <b>INPUT GUIDE</b> will disappear after 3 seconds without any operation.
<b>OFF</b>	Turn off the guidance.

## OSD DESIGN

You can change the background colour of the menu. Press ◀ ▶ to cycle through the options.

- **TYPE1**      Semi transparent black
- **TYPE2**      Solid blue
- **TYPE3**      Semi transparent dark blue

## OSD POSITION

You can change the displaying position of the menu. Press ◀ ▶ to cycle through the options.

UPPER LEFT	UPPER CENTRE	UPPER RIGHT
	CENTRE	
LOWER LEFT	LOWER CENTRE	LOWER RIGHT

## BACK COLOUR

You can choose a screen colour from **BLUE** or **BLACK** for when the projector is in idle. Press ◀ ▶ to select.

## STARTUP LOGO

You can switch the logo on/off that is displayed when starting up the projector. Press ◀ ▶ to select the required option. **STARTUP LOGO** will be displayed for 15 seconds.

- **ON**              Active
- **OFF**             Deactive

## AUTO SEARCH

When the projector is turned on, the input terminals are detected and an input signal is selected automatically. You can switch the system on/off. Press ◀ ▶ to cycle through the options.

- **ON**              Active
- **OFF**             Deactive

### NOTE:

- When no signal is detected, the last used input will be selected.

## HDMI SIGNAL LEVEL

When an **HDMI IN** is selected, you can switch the **HDMI** signal **NORMAL** or **EXPAND** to display the image. Press ◀ ▶ to select an option.

- **NORMAL**      For general HDMI equipment
- **EXPAND**      For HDMI equipment with expanded signals.

### NOTE:

- **HDMI SIGNAL LEVEL** is not available with some equipment.

## FRAME RESPONSE

You can minimise the time delay of image displayed for the progressive signals.

- **NORMAL**      Prioritise the image quality
- **FAST**            Prioritise the frame response

## INSTALLATION

When installing the projector, select the projection method according to the projector position. Press ◀ ▶ to cycle through the options. See “Projection method” on page 15.

FRONT/DESK	Setting on a desk/floor and projecting from front
FRONT/CEILING	Mounting on the ceiling and projecting from front
REAR/DESK	Setting on a desk/floor and projecting from rear
REAR/CEILING	Mounting on the ceiling and projecting from rear

## SLEEP

You can select the required duration of time and set the off timer to turn off the power of the projector automatically. 3 minutes before turn-off, the countdown of minutes will be displayed in the lower right corner. Press ◀ ▶ to cycle through the options.

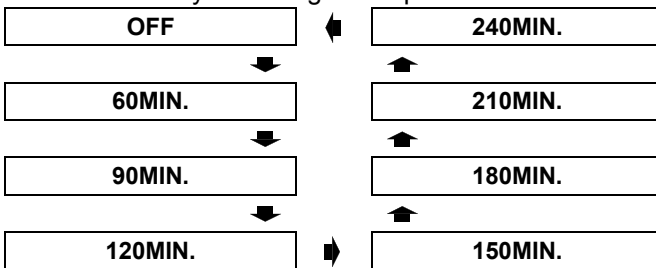

## HIGH ALTITUDE MODE

If you use the projector at high elevation, the **HIGH ALTITUDE MODE** setting need to be **ON** to set the fan speed high. Press ◀ ▶ to select the required option.

- OFF The fan speed is low.
- ON The fan speed is high.

### NOTE:

- At 1 400 - 2 700 m (4 593 - 8 858 ft) above sea level, the setting must be **ON**.
- The loudness of fan noise depends on the **HIGH ALTITUDE MODE** setting.

## LAMP POWER

You can adjust the power of the lamp to save on electricity, prolong the lamp life and reduce the noise.

Options	Function
NORMAL	When higher luminance is required.
ECO-MODE	When lower luminance is sufficient.

### NOTE:

- When no input signal is detected, the function is disabled.

## LAMP RUNTIME

You can check how long the lamp has been used.

### NOTE:

- **LAMP RUNTIME** is a relevant matter for lamp replacement timing. See “Replacing the lamp unit” on page 47.

# TEMP and LAMP Indicators

## Managing the indicated problems

If a problem should occur with the projector, the **LAMP** and/or **TEMP** indicators will inform you. Manage the indicated problems as follows.

1. Confirm the status of all indicators and projector, and switch off the projector in proper way.
2. Find out the cause of the problem by status of the **LAMP** and/or **TEMP** indicators.
3. Follow the following instruction for each indication and solve the problem.
4. Turn on the projector in the correct way and confirm the indicator is not indicating a problem any longer.

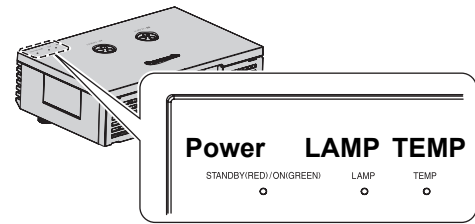

### LAMP indicator

<b>Indicator</b>	Illuminating red	Flashing red		
<b>Problem</b>	<b>LAMP RUNTIME</b> has reached 1 800 hours.	Lamp circuit failure, abnormal function or lamp unit is damaged.		
<b>Cause</b>	The lamp unit will run out soon and needs to be replaced.	The <b>MAIN POWER</b> is switched on again before the lamp unit is cooled enough.	Lamp circuit failure, abnormal function.	The lamp unit is damaged.
<b>Remedy</b>	See "Replacing the lamp unit" on page 47.	Let the lamp unit cool down and turn on the <b>MAIN POWER</b> after 90 seconds.	Contact an Authorised Service Centre.	See "Replacing the lamp unit" on page 47.

### TEMP indicator

<b>Indicator</b>	<ul style="list-style-type: none"> <li>● Illuminating red while projecting and the alert will be displayed.</li> <li>● Flashing red and the power button is turned off.</li> </ul>			
<b>Problem</b>	The temperature inside and/or outside the projector is abnormally high.			
<b>Cause</b>	The ventilation openings are covered.	The room temperature is too high.	The air filter is excessively dirty and the ventilation is poor.	The projector is located at high elevations (above 1 400 - 2 700 m).
<b>Remedy</b>	Remove the object(s) from the ventilation openings or clear around the projector.	Reinstall the projector in a temperature controlled place. See page 54.	Replace the air filter in the proper method. See page 46.	Turn on the projector and set the <b>HIGH ALTITUDE MODE</b> to <b>ON</b> . See page 44.

#### NOTE:

- If no problem is found or the problem remains, do not turn on the projector. Instead contact an Authorised Service Centre.

# Care and Replacement

## Cleaning the projector

### Before cleaning the projector

- Switch off the **MAIN POWER** switch in proper way and disconnect the mains plug from the mains socket.
- Unplug all the cables from the projector.

### Cleaning the outer surface of the projector

Wipe off dirt and dust gently with a soft cloth.

- If it is difficult to remove the dirt, soak a cloth in water, wring the cloth well and then wipe the projector. Dry off the projector with dry cloth.
- Do not use petroleum benzene, thinner, any alcoholic solvent, kitchen detergents or chemical clothes. Failure to observe these may result in altered or damaged surface of the projector.

### Cleaning the lens surface

Wipe off dirt and dust gently with a lint-free cloth.

- Make sure no dirt or dust remains on the surface of the lens. It will be enlarged and projected onto a screen.

### Cleaning the air filter

If the air filter is excessively dirty, the internal temperature of the projector increases and may cause malfunction. Clean the air filter regularly every 100 hours of usage.

1. Place a finger at the bottom of the air filter.
2. Slightly push up and pull out the air filter to remove.

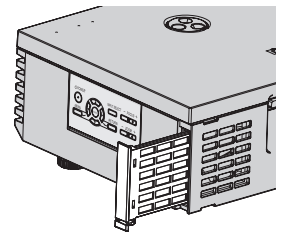

3. Vacuum dirt and dust from the air filter.

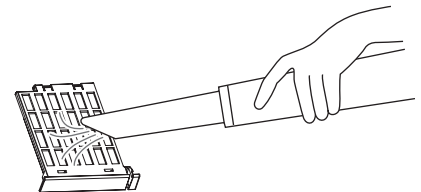

- Do not wash the air filter.
4. Place and slightly slide in the air filter in the air intake port to attach.
    - Make sure the air filter clicks into the place.

#### NOTE:

- Do not use the projector without attaching the air filter.

### Replacing the air filter

The air filter should be replaced when cleaning is ineffective and when replacing the lamp unit. A replacement air filter (TXFKN01VKF5) is provided with a replacement lamp unit, ET-LAE1000. Contact an Authorised Service Centre for the optional air filter.

## Replacing the lamp unit

### Before replacing the lamp unit



- Switch off the **MAIN POWER** button in proper way and disconnect the mains plug from the mains socket.
- Wait for more than 1 hour and make sure the lamp unit and the surroundings are cooled enough.
- Unplug all the cables from the projector.
- Prepare a Phillips-head screwdriver.
- Contact an Authorised Service Centre to purchase a replacement lamp unit (ET-LAE1000).
- When the projector is mounted on the ceiling, do not work directly under the projector or put your face closer to the projector.

#### NOTE:

- Prior to replacing the lamp unit, allow it to cool down to prevent the risk of burns, damage and other hazards.
- Do not attempt replacement with an unauthorised lamp unit.

### When to replace the lamp unit

The lamp unit is consumable and the brightness decreases by duration of usage. The **LAMP** indicator will inform you of the replacement timing at 1 800 hours, and at 2 000 hours, the projector will be turned off. Those figures are rough guidance and might be shortened by the usage conditions, characteristics of the lamp unit, environmental conditions, and so on. You can check the duration of usage time using **LAMP RUNTIME** in the **OPTION** menu.

Indication	On screen	LAMP indicator
		
Over 1 800 hours	"REPLACE LAMP" is displayed on the upper left of the screen for 30 seconds. To clear the screen immediately, press any button.	Illuminates red.
Over 2 000 hours	"REPLACE LAMP" is displayed on the upper left of the screen, and it will stay until you respond. To clear the screen, press any button.	

#### NOTE:

- The guide times, 1 800 and 2 000 hours, are rough estimates based on certain conditions and is not a guaranteed time. The estimated condition is: **LAMP POWER** in **OPTION** menu set to **NORMAL**.
- To prolong the lamp life, set the **LAMP POWER** in **OPTION** menu to **ECO-MODE**. See "LAMP POWER" on page 44.
- For more information about the lamp unit, such as guaranteed time, see the instructions which is provided with the lamp unit.

### Opening the top cover

1. Hold at the back corner of the top cover and slightly push up to open.
2. Unhook the top cover safety hook from the projector.
3. Hold the top cover up and press the sides of each hinge parts to remove.
  - When the projector is mounted on the ceiling, removing the hinge parts is not required.
4. Remove the top cover aside.

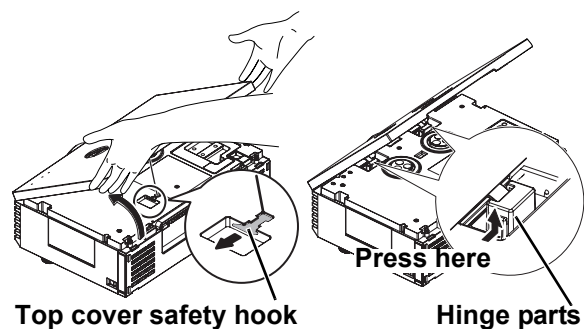

#### NOTE: When the projector is mounted on the ceiling:

- Place yourself at back side of the projector, then open and close the top cover.
- Do not work directly under the projector or put your face closer to the projector.

## Care and Replacement

### Removing and replacing the lamp unit

1. Use a Phillips screw driver to loosen the 3 lamp unit fixing screws until the screws turn freely.

Lamp unit fixing screws

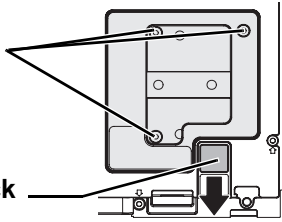

Lamp unit lock

2. Hold the handle of the lamp unit and release the lamp unit lock.
3. Pull out the lamp unit gently from the projector.

4. Replace the new lamp unit while making sure that the direction of insertion is correct.
  - Press the top of the lamp unit and make sure the unit is installed securely.

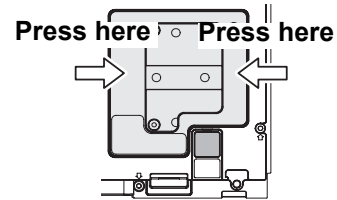

5. Tighten the lamp unit fixing screws securely with a Phillips screwdriver.

### Attaching the top cover

1. Attach the hinge parts of the top cover to the projector and press slightly until it clicks.
  - When the projector is mounted on the ceiling, attaching the hinge parts is not required.
2. Hook the top cover safety hook to the projector.
3. Hooking the tabs of the top cover to the front of the projector and lift down slowly.
4. Press the back corner of the top cover gently until it clicks.
  - Make sure to hook the top cover safety hook to the body.

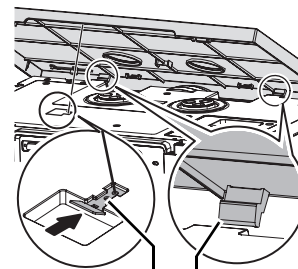

Top cover safety hook Hinge part

#### NOTE:

- Be sure to install the lamp unit and the top cover of the projector securely. If they are not securely installed, it may cause the protection circuit to operate so that the power cannot be turned on.
- Grip the handle and keep the lamp unit paralleled when you remove the lamp unit.
- Do not switch the power on while the top cover is opened.
- When the projector is mounted on the ceiling, keep the lamp unit paralleled up and remove.

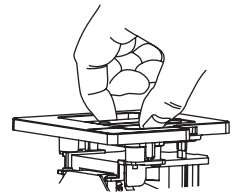

### Resetting the LAMP RUNTIME

If the lamp usage time has passed 2 000 hours (when **LAMP POWER** has been set to **NORMAL**), the projector will switch to standby mode after approximately 10 minutes of operation. The resetting procedure should thus be completed within 10 minutes.

1. Connect the mains lead to the projector and a mains socket, and switch the **MAIN POWER** on.
2. Switch the power button.
3. Press the **MENU** button to display the menu.
4. Press **▲ ▼** to select **OPTION** and press **ENTER**.
5. Press **▲ ▼** to select **LAMP RUNTIME**.
6. Press and hold the **ENTER** button for approximately 3 seconds.
7. The confirmation screen will be displayed and select **OK**.
8. Switch off the power button to reset the duration of the **LAMP RUNTIME**.
9. Confirm the duration of time in **LAMP RUNTIME** is reset to "0".

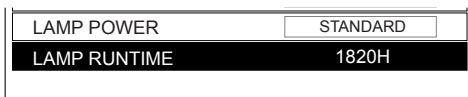



# Troubleshooting

Should any problem persist, contact your dealer.

Problem	Cause	Reference page
<b>Power does not turn on.</b>	● The mains lead may not be connected.	19
	● The <b>MAIN POWER</b> switch is turned off.	21
	● No electric supply is at the mains socket.	19
	● <b>TEMP</b> indicator is lit or flashes.	45
	● <b>LAMP</b> indicator is lit or flashes.	45
	● The lamp unit cover has not been securely installed.	47
	● The circuit breakers have tripped.	-
<b>No picture appears.</b>	● The video signal input source may not be connected to a terminal properly.	18
	● The input selection setting may not be correct.	28
	● The <b>BRIGHTNESS</b> adjustment setting may be at the minimum setting.	32
	● The <b>SHUTTER</b> function may be in use.	42
	● The lens cover may still be attached to the lens.	12
<b>The picture is fuzzy.</b>	● The lens focus may not have been set correctly.	22
	● The projector may not be at the correct distance from the screen.	14
	● The lens may be dirty.	46
	● The projector may be tilted too much.	16
<b>The colour is pale or greyish.</b>	● <b>COLOUR</b> or <b>TINT</b> adjustment may be incorrect.	32
	● The equipment which is connected to the projector may not be adjusted correctly.	-
<b>The Remote control does not operate.</b>	● The batteries may be weak.	-
	● The batteries may not have been inserted correctly.	11
	● The remote control signal receptor on the projector may be obstructed.	23
	● The remote control unit may be out of the operation range.	23
<b>The picture does not display correctly.</b>	● The signal format ( <b>TV-SYSTEM</b> ) may not have been set correctly.	35
	● There may be a problem with the VCR or other signal source.	-
	● A signal which is not compatible with the projector is being input.	50
<b>Picture from a computer does not appear.</b>	● The cable may be longer than the optional cable.	-
	● The external video output from a laptop computer may not be correct. (You may be able to change the external output settings by pressing the [Fn] + [F3] or [Fn] + [F10] keys simultaneously. The actual method varies depending on the type of computer; refer to the documentation provided with your computer for further details.)	-

# Technical Information

## List of compatible signals

Mode	Display	Display resolution (dots) <sup>*1</sup>	Scanning frequency		Dot clock frequency (MHz)	Picture quality <sup>*2</sup>	Terminals
			H (kHz)	V (Hz)			
NTSC/NTSC 4.43/ PAL-M/PAL60	-	720 x 480i	15.7	59.9	-	A	VIDEO/S-VIDEO
PAL/PAL-N/SECAM	-	720 x 576i	15.6	50.0	-	A	
525i (480i)	525i	720 x 480i	15.7	59.9	13.5	A	COMPONENT
625i (576i)	625i	720 x 576i	15.6	50.0	13.5	A	
525p (480p)	525p	720 x 483	31.5	59.9	27.0	A	COMPONENT/HDMI
625p (576p)	625p	720 x 576	31.3	50.0	27.0	A	
1 125 (1 080)/60i	1 125/60i	1 920 x 1 080i	33.8	60.0	74.3	AA	COMPONENT/ HDMI/COMPUTER
1 125 (1 080)/50i	1 125/50i	1 920 x 1 080i	28.1	50.0	74.3	AA	
1 125 (1 080)/24p	1 125/24p	1 920 x 1 080	27.0	24.0	74.3	AA	COMPONENT/HDMI
1 125 (1 080)/60p	1 125/60p	1 920 x 1 080	67.5	60.0	148.5	AA	
1 125 (1 080)/50p	1 125/50p	1 920 x 1 080	56.3	50.0	148.5	AA	COMPONENT/ HDMI/COMPUTER
750 (720)/60p	750/60p	1 280 x 720	45.0	60.0	74.3	AA	
750 (720)/50p	750/50p	1 280 x 720	37.5	50.0	74.3	AA	COMPONENT/HDMI
VGA480	VGA60	640 x 480	31.5	59.9	25.2	A	
	VGA75	640 x 480	37.5	75.0	31.5	A	COMPUTER
	VGA85	640 x 480	43.3	85.0	36.0	A	
	VGA138	640 x 480	72.1	138.0	62.3	A	
SVGA	SVGA55	800 x 600	35.2	56.3	36.0	A	
	SVGA60	800 x 600	37.9	60.3	40.0	A	
	SVGA70	800 x 600	48.1	72.2	50.0	A	
	SVGA75	800 x 600	46.9	75.0	49.5	A	
	SVGA85	800 x 600	53.7	85.1	56.3	A	
WIDE720	WIDE720	1 280 x 720	45.1	60.1	76.5	AA	
XGA	XGA60	1 024 x 768	48.4	60.0	65.0	A	
	XGA70	1 024 x 768	56.5	70.1	75.0	A	
	XGA75	1 024 x 768	60.0	75.0	78.8	A	
	XGA85	1 024 x 768	68.7	85.0	94.5	A	
	XGA89	1 024 x 768	72.1	89.0	99.2	A	
WIDE768	WIDE768	1 280 x 768	45.3	56.5	76.2	A	
MXGA	MXGA70	1 152 x 864	64.0	71.2	94.2	A	
	MXGA75	1 152 x 864	67.5	74.9	108.0	A	
SXGA	SXGA60	1 280 x 1 024	64.0	60.0	108.0	A	
SXGA60+	SXGA60+	1 400 x 1 050	65.1	59.9	122.4	A	
WIDE768-2	WIDE768-2	1 360 x 768	48.8	59.8	74.3	A	
WIDE800	WIDE800	1 280 x 800	49.7	59.8	83.5	A	
WIDE900	WIDE900	1 440 x 900	55.9	59.8	106.5	A	
WIDE1080/60	WIDE1080/60	1 920 x 1 080	66.5	59.9	138.5	AA	
WIDE1080/50	WIDE1080/50	1 920 x 1 080	55.6	49.9	141.5	AA	

\*1. The "i" appearing after the resolution indicates an interlaced signal.

\*2. The following symbols are used to indicate picture quality.

AA Maximum picture quality can be obtained.

A Signals are converted by the image processing circuit before picture is projected.

## Serial terminal

The serial connector which is on the connector panel of the projector conforms to the RS-232C interface specification, so that the projector can be controlled by a personal computer which is connected to this connector.

### Connection

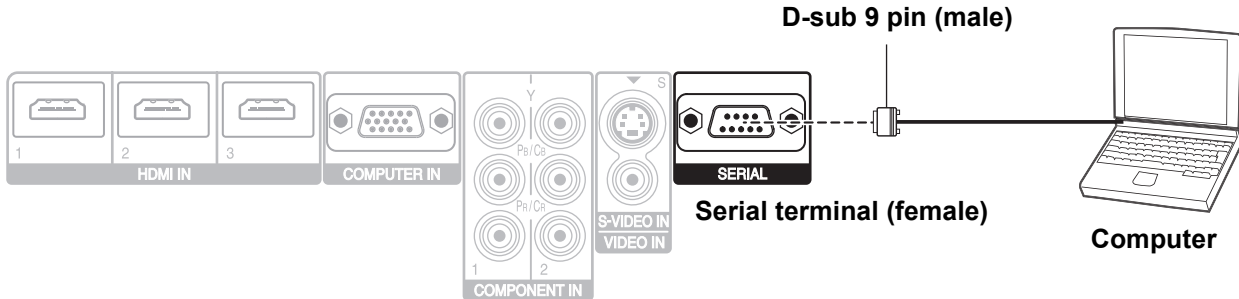

#### NOTE:

- You must use only an RS-232C Serial Interface Cable with a ferrite core, type ET-ADSER.

### Pin assignments and signal names

	Pin No.	Signal name	Contents
	①		NC
	②	TXD	Transmitted data
	③	RXD	Received data
	④		NC
	⑤	GND	Earth
	⑥		NC
	⑦	RTS	Connected internally
	⑧	CTS	
	⑨		NC

### Cable specifications

(When connected to a personal computer)

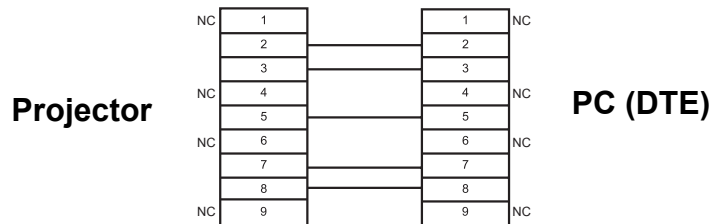

### Basic format

STX	Command	:	Parameter	ETX	
Start byte (02h)	3 bytes	1 byte	1 byte - 4 bytes	End (03h)	The data streaming from the computer will start with STX, and proceed to Command, Parameter and end with ETX. You can add the required parameter.

- The projector can not receive any command for 10 seconds after the lamp is switched on. Wait 10 seconds before sending the command.
- If sending multiple commands, check that a response has been received from the projector for one command before sending the next command.
- When a command which does not require parameters to be sent, the colon (:) is not required.
- If an incorrect command is sent from the personal computer, the ER401 command will be sent from the projector to the personal computer.

## Technical Information

### Communication settings

Signal level	RS-232C	Character length	8 bits
Sync. method	Asynchronous	Stop bit	1 bit
Baud rate	9 600 bps	X parameter	None
Parity	None	S parameter	None

### Control commands

Command	Control contents	Remarks
<b>PON</b>	POWER ON	In standby mode, all commands other than the PON command are ignored. The PON command is ignored during lamp ON control.
<b>POF</b>	POWER OFF	If a PON command is received while the cooling fan is operating after the lamp has switched off, the lamp is not turned back on again straight away in order to protect the lamp.
<b>IIS</b>	INPUT	Parameter: CP1 = COMPONENT1 IN                      CP2 = COMPONENT2 IN SVD = S-VIDEO IN                        VID = VIDEO IN HD1 = HDMI1 IN                         HD2 = HDMI2 IN HD3 = HDMI3 IN                         RG1 = COMPUTER IN
<b>OMN</b>	MAIN	Displaying the main menu.
<b>OEN</b>	ENTER	Activating the selected items in the menu mode.
<b>OBK</b>	RETURN	Returning to the previous menu or escaping from the menu mode.
<b>OCU/ OCD/ OCL/ OCR</b>	Navigation buttons	OCU = ▲ button                              OCL = ◀ button OCD = ▼ button                              OCR = ▶ button
<b>OLE</b>	LENS	Activating the LENS CONTROL menu.
<b>OST</b>	DEFAULT	Resetting to the factory default setting. (page 28)
<b>OFZ</b>	FREEZE	Freezing the projected screen. Parameter: 0 = OFF    1 = ON
<b>FCI</b>	FUNCTION BUTTON	Activates the function that is assigned to the FUNCTION button of the remote control.
<b>OOT</b>	SLEEP	Setting the duration of time to turn off the power automatically. (See "SLEEP" on page 44.) 0 = OFF                      1 = 60min.                      2 = 90min.                      3 = 120min.                      4 = 150min. 5 = 180min.                      6 = 210min.                      7 = 240min.
<b>OSH</b>	BLANK	Turning off the projection temporarily. Send the command to switch between ON and OFF. Do not send the command consecutively.
<b>OVM</b>	PICTURE	Activating the PICTURE menu. Send the command to switch menu items. (page 23)
<b>OWM</b>	WAVEFORM	Activating the WAVEFORM. (page 24) Parameter: 0 = OFF 1 = FULL SCAN (Y)                              5 = SINGLE LINE SCAN (Y) 2 = FULL SCAN (R)                              6 = SINGLE LINE SCAN (R) 3 = FULL SCAN (G)                              7 = SINGLE LINE SCAN (G) 4 = FULL SCAN (B)                              8 = SINGLE LINE SCAN (B)
<b>VS1</b>	ASPECT	Switching the aspect ratio. (page 24)
<b>VPM</b>	PICTURE MODE	Switching the PICTURE MODE. (page 23) Parameter: NOR = NORMAL    DYN = DYNAMIC    CL1 = COLOUR1    CL2 = COLOUR2 CN1 = CINEMA1    CN2 = CINEMA2    CN3 = CINEMA3

**Inquiry commands**

Command	Control contents	Parameter			
<b>QPW</b>	Power status	000 = OFF	001 = ON		
<b>QFZ</b>	FREEZE status	0 = OFF	1 = ON		
<b>QIN</b>	INPUT signal status	CP1 = COMPONENT1 IN SVD = S-VIDEO IN HD1 = HDMI1 IN HD3 = HDMI3 IN	CP2 = COMPONENT2 IN VID = VIDEO IN HD2 = HDMI2 IN RG1 = COMPUTER IN		
<b>QOT</b>	OFF TIMER status	0 = OFF 5 = 180min.	1 = 60min. 6 = 210min.	2 = 90min. 7 = 240min.	3 = 120min. 4 = 150min.
<b>QPM</b>	PICTURE MODE status	NOR = NORMAL CN1 = CINEMA1	DYN = DYNAMIC CN2 = CINEMA2	CL1 = COLOUR1 CN3 = CINEMA3	CL2 = COLOUR2
<b>QSH</b>	BLANK status	0 = OFF	1 = ON		
<b>QWM</b>	WAVEFORM status	Parameter: 0 = OFF 1 = FULL SCAN (Y) 2 = FULL SCAN (R) 3 = FULL SCAN (G) 4 = FULL SCAN (B)	5 = SINGLE LINE SCAN (Y) 6 = SINGLE LINE SCAN (R) 7 = SINGLE LINE SCAN (G) 8 = SINGLE LINE SCAN (B)		

## Technical Information

### Specifications

<b>Power supply</b>		AC 100 - 240 V 50 Hz/60 Hz
<b>Power consumption</b>		Less than 240 W During standby (when fan is stopped): 0.08 W (at 220 V)
<b>Amps</b>		3.0 A - 1.6 A
<b>LCD panel</b>	<b>Panel size (diagonal)</b>	0.74 type (17.78 mm)
	<b>Aspect ratio</b>	16 : 9
	<b>Display method</b>	3 transparent LCD panels (RGB)
	<b>Drive method</b>	Active matrix method
	<b>Pixels</b>	2 073 600 (1 920 x 1 080) x 3 panels
<b>Lens</b>		Motorised zoom (2x)/Motorised focus F 1.9 - 3.1, f 22.4 mm - 44.8 mm
<b>Lamp</b>		UHM lamp (165 W)]
<b>Luminosity<sup>*1</sup></b>		1 600 lm
<b>Operating environment</b>		Temperature 0 °C - 40 °C (32 °F - 104 °F) When the HIGH ALTITUDE MODE (page 44) is set to ON: 0 °C - 35 °C (32 °F - 95 °F) Humidity 20% - 80% (no condensation)
<b>Scanning frequency<sup>*2</sup> (for RGB signal)</b>	<b>Horizontal scanning frequency</b>	30 kHz - 70 kHz
	<b>Vertical scanning frequency</b>	50 Hz - 87 Hz
	<b>Dot clock frequency</b>	Less than 150 MHz
<b>COMPONENT (YPbPr) signals</b>		525i (480i), 525p (480p), 625i (576i), 625p (576p), 750 (720)/60p, 750 (720)/50p, 1 125 (1 080)/60i, 1 125 (1 080)/50i, 1 125 (1 080)/60p, 1 125 (1 080)/50p, 1 125 (1 080)/24p
<b>Colour system</b>		7 (NTSC/NTSC 4.43/PAL/PAL-M/PAL-N/PAL60/SECAM)
<b>Projection size</b>		40" - 200" (1 016 mm - 5 080 mm)
<b>Throw distance</b>		1.2 m - 12 m (3'11" - 39'4")
<b>Screen aspect ratio</b>		16 : 9
<b>Installation</b>		FRONT/DESK, FRONT/CEILING, REAR/DESK, REAR/CEILING (Menu selection method)

\*1. Measurement, measuring conditions and method of notation all comply with ISO 21118 international standards.

\*2. See "List of compatible signals" on page 50 for available signals.

## Technical Information

<b>Terminals</b>	<b>S-VIDEO IN</b>	Single - line, Mini DIN 4p Y: 1.0 V [p-p], C: 0.286 V [p-p], 75 Ω
	<b>VIDEO IN</b>	Single - line, RCA pin jack 1.0 V [p-p], 75Ω
	<b>COMPUTER IN</b>	Single - line, D - sub HD 15-pin (female) Selectable for input and output by menu operation.
		R.G.B. 0.7 V [p-p], 75 Ω
		G.SYNC 1.0 V [p-p], 75 Ω
		HD/SYNC TTL high impedance, automatic positive/negative polarity compatible
VD TTL high impedance, automatic positive/negative polarity compatible		
<b>COMPONENT IN</b>	Y, PB/CB, PR/CR Dual - line, RCA pin jack x 3 Y: 1.0 V [p-p] (including sync), 75 Ω PB/CB, PR/CR 0.7 V [p-p], 75 Ω	
<b>HDMI IN</b>	Triple - line, 19-pin HDMI connector (HDCP compliant)	
<b>SERIAL</b>	D-sub 9-pin RS-232C compatible	
<b>Cabinet</b>	Moulded plastic (PC+ABS)	
<b>Dimensions</b>	Width	460 mm (18 -3/32")
	Height	130 mm (5 -3/32")
	Length	300 mm (11 -25/32")
<b>Weight</b>	Approx. 7.3 kg (16.09 lbs.)* <sup>1</sup>	
<b>Certifications</b>	EN60950-1, EN55022, EN61000-3-2, EN61000-3-3, EN55024	
<b>Remote control</b>	<b>Power supply</b>	3 V DC (AA battery x 2)
	<b>Operating range</b>	Approx. 7 m (23') (when operated directly in front of signal receptor)
	<b>Weight</b>	125 g (4.4 ozs.) (including batteries)
	<b>Dimensions</b>	Width
Length		138 mm (5 -13/32")
Height		28.35 mm (1 -3/32") (not including surface projection parts)
<b>Options</b>	<b>Cable cover</b>	ET-PCE2000
	<b>Ceiling bracket</b>	ET-PKE2000/ET-PKE1000S

\*1. Average value. Each product has an individual variability in weight.

### Ceiling mount bracket safeguards

The projector and the ceiling mount bracket are designed for sufficiently safety however, make sure the safety cable provided with the projector is installed and attached to the bottom of the projector when mounting on the ceiling for safety and security.

#### NOTE:

- Even if it is during guarantee period, the manufacturer is not responsible for any hazard or damage caused by using a ceiling mount bracket which is not purchased from an authorised distributors, or environmental conditions.
- Make sure to use a torque driver and do not use an electrical screwdriver or an impact screwdriver.
- Installation work of the ceiling mount bracket should only be carried by a qualified technician.
- Remove an unused ceiling mount bracket promptly.

#### Installing the safety cable

1. Install the ceiling mount bracket according to the Installation Instructions.
2. Loop the security cable around the ceiling mount bracket with less slack.
  - Lace the cable of the end with a latch through the loop on the other end of the cable.

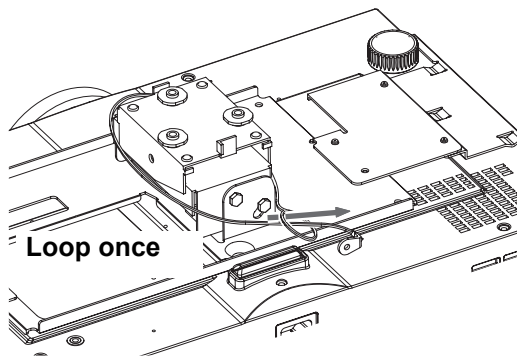

\* Indicated above is ET-PKE1000S.

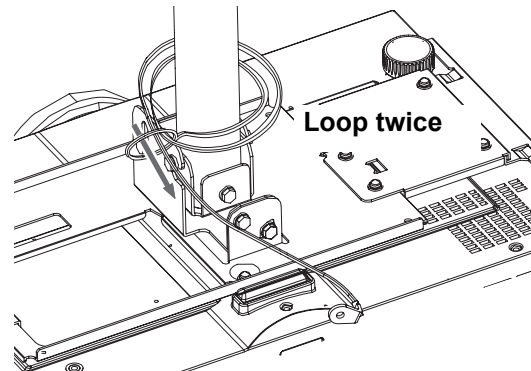

\* Indicated above is ET-PKE2000

3. Attach the latch on to the bottom of the projector with a provided screw.
  - Torque:  $1.25 \pm 0.2$  N·m

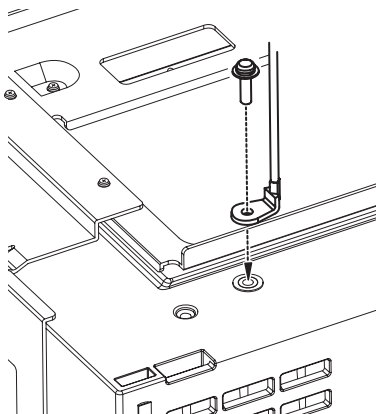



## Dimensions

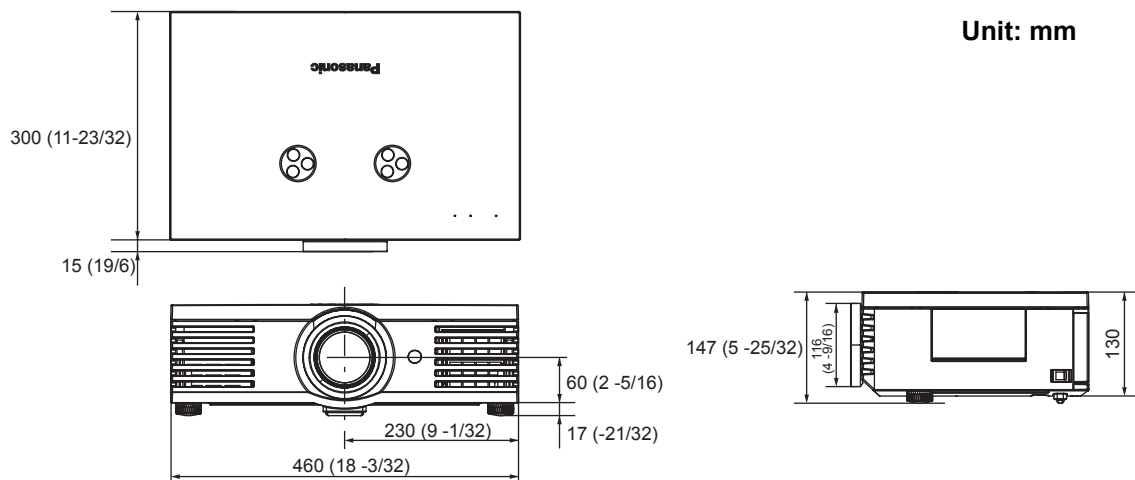

## Trademark acknowledgements

- VGA and XGA are trademarks of International Business Machines Corporation.
- S-VGA is a registered trademark of the Video Electronics Standards Association.
- HDMI, the HDMI logo and High-Definition Multimedia Interface are trademarks or registered trademarks of HDMI Licensing LLC.
- The font used in the on-screen displays is a Ricoh bitmap font, which is manufactured and sold by Ricoh Company, Ltd.

All other trademarks are the property of the various trademark owners.

# Index

<b>A</b>			
AC IN .....	13	Front leg adjusters .....	13, 15
Accessories .....	10	FUNCTION	
ADVANCED MENU .....	34	Remote control button .....	11
Air exhaust port .....	12	Remote control function .....	28
Air filter .....	12	FUNCTION BUTTON	
Replacing .....	46	Main menu .....	42
Air intake port .....	13	Remote control buttons .....	11
ASPECT .....	37	Remote control function .....	28
Remote control button .....	11	<b>G</b>	
Remote control function .....	24	GAMMA .....	34
AUTO SEARCH .....	43	<b>H</b>	
AUTO SETUP .....	39	H-AREA POSITION .....	41
<b>B</b>		HDMI IN	
BACK COLOUR .....	43	Connection .....	18
Batteries		Terminal .....	13
Accessory .....	10	HDMI SIGNAL LEVEL .....	43
Compartment .....	11	HIGH ALTITUDE MODE .....	44
BLANK .....	42	H-FIT .....	38
BRIGHTNESS		H-POSITION .....	37
ADVANCED MENU .....	34	<b>I</b>	
PICTURE menu .....	32	INPUT GUIDE .....	43
BUTTON .....	42	INPUT SELECT	
<b>C</b>		Control panel button .....	12
Ceiling mount bracket .....	56	Remote control button .....	11
CINEMA REALITY .....	35	Remote control function .....	28
Cleaning .....	46	INSTALLATION	
CLOCK PHASE .....	37	POSITION menu .....	44
COLOUR .....	32	Projection method .....	15
COLOUR MANAGEMENT .....	35	<b>J</b>	
Remote control button .....	11	JUST .....	38
Remote control function .....	26	<b>K</b>	
COLOUR TEMPERATURE .....	33	KEYSTONE .....	39
COMPONENT IN		<b>L</b>	
Connection .....	18	LAMP	
Terminal .....	13	Indicator .....	12
COMPUTER IN		Indicator status .....	45
Connection .....	18	LAMP POWER .....	44
Terminal .....	13	LAMP RUNTIME .....	44, 48
Connections .....	18	Lamp unit	
CONTRAST		Replacing .....	47
ADVANCED MENU .....	34	LENS	
PICTURE menu .....	32	Remote control button .....	11
<b>D</b>		Remote control function .....	23
DEFAULT		LENS CONTROL	
Remote control button .....	11	Main menu .....	40
Remote control function .....	28	Remote control button .....	11
DETAIL CLARITY .....	35	Lens cover .....	12
Dimensions .....	57	Accessory .....	10
DOT CLOCK .....	37	Attachment hole .....	13
DYNAMIC IRIS .....	33	LENS MEMORY	
<b>E</b>		EDIT .....	41
ENTER		LOAD .....	40
Control panel button .....	12	SAVE .....	40
Remote control button .....	11	Lens shift	
<b>F</b>		Lens shift dial • Horizontal .....	12
FOCUS		Lens shift dial • Vertical .....	12
Control panel button .....	12	<b>M</b>	
LENS CONTROL menu .....	40	MAIN POWER .....	12
FRAME CREATION .....	35	Mains lead	
FRAME RESPONSE .....	43	Accessory .....	10
FREEZE		Connecting .....	19
Remote control button .....	11	MEMORY EDIT .....	36
Remote control function .....	28		

MEMORY LOAD .....	36	SERIAL	
Remote control button .....	11	Basic format .....	51
Remote control function .....	24	Cable specifications .....	51
MEMORY SAVE .....	36	Communication settings .....	52
MENU		Connection .....	51
Control panel button .....	12	Control commands .....	52
Remote control button .....	11	Inquiry commands .....	53
Remote control function .....	29	Pin assignments .....	51
Menu		Terminal .....	13
Main menu .....	30	SHARPNESS .....	32
Navigation .....	29	SLEEP .....	44
Sub-menu .....	30	Specifications .....	54
MPEG NR .....	35	SPLIT ADJUST .....	33
<b>N</b>		STARTUP LOGO .....	43
Navigation buttons		S-VIDEO IN	
Control panel button .....	12	Connection .....	18
Remote control button .....	11	Terminal .....	13
NR (Noise Reduction) .....	34	<b>T</b>	
<b>O</b>		Technical Information .....	50
OPTION menu .....	43	TEMP	
OSD DESIGN .....	43	Indicator .....	12
OSD POSITION .....	43	Indicator status .....	45
OVER SCAN .....	39	Throw distance .....	14
<b>P</b>		Throwing angle .....	15
PICTURE .....	32	TINT .....	32
Remote control button .....	11	Top cover .....	13, 47
Remote control function .....	23	Troubleshooting .....	49
PICTURE ADJUST		TV-SYSTEM .....	35
Remote control button .....	11	<b>V</b>	
Remote control function .....	23	V-AREA POSITION .....	41
PICTURE MODE .....	32	VIDEO IN	
Remote control button .....	11	Connection .....	18
Remote control function .....	23	Terminal .....	13
POSITION .....	37	V-FIT .....	38
Power		V-POSITION .....	37
Control panel button .....	12	<b>W</b>	
Indicator .....	12	WAVEFORM MONITOR .....	33
Indicator status .....	20	Remote control button .....	11
Remote control button .....	11	Remote control function .....	24
Power cord secure lock .....	10, 19	WSS .....	39
<b>R</b>		<b>X</b>	
Remote control .....	11	xvColour .....	35
Accessory .....	10	<b>Z</b>	
Operating range .....	23	ZOOM	
Operation .....	23	ASPECT menu .....	38
Signal emitter .....	11	Control panel button .....	12
Signal receptor .....	12	LENS CONTROL menu .....	40
RETURN		ZOOM/FOCUS .....	40
Control panel button .....	12	ZOOM1 .....	38
Remote control button .....	11	ZOOM2 .....	38
Remote control function .....	29		
<b>S</b>			
Safety cable .....	56		
Accessory .....	10		
Attachment point .....	13		
Screen size .....	14		
Calculation methods .....	14		
Security lock .....	13		

---

# Panasonic Corporation

Web Site : <http://panasonic.net/pavc/projector/>  
© Panasonic Corporation 2008

Printed in Japan  
S0908-1098B