





DLP TV

SP50L7HX
SP56L7HX

Owner's Instructions

Before operating the unit,
please read this manual thoroughly,
and retain it for future reference.

PICTURE IN PICTURE (PIP)
COLOUR WEAKNESS ENHANCEMENT MODE
MY COLOUR CONTROL
 **SRS TruSurroundXT**
 **DIGITAL NATURAL IMAGE ENGINE**

This device is a Class B digital apparatus.

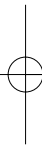
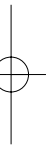

Contents

◆ CONNECTING AND PREPARING YOUR TELEVISION

■ Control Panel of Your Television	5
■ Connection Panel of Your Television	6
■ Connecting to an Aerial or Cable Television Network	8
■ Connecting a Satellite Receiver or Decoder.....	8
■ Infrared Remote Control	9
■ Inserting the Batteries in the Remote Control.....	10
■ Switching Your Television On and Off.....	11
■ Placing Your Television in Standby Mode	11
■ Becoming Familiar with the Remote Control	12
■ Plug & Play Feature.....	13
■ Choosing Your Language.....	14

◆ USING YOUR TELEVISION

■ Storing Channels Automatically.....	15
■ Storing Channels Manually.....	16
■ Skipping Unwanted Channels	18
■ Sorting the Stored Channels	19
■ Activating the Child Lock	20
■ Assigning Names to Channels	21
■ Fine Tuning Channel Reception	22
■ Using the LNA (Low Noise Amplifier) Feature.....	23
■ Viewing the Channel Scan Picture	23
■ Displaying Information.....	24
■ Freezing the Current Picture	24
■ Changing the Picture Standard	25
■ Adjusting the Picture Settings.....	26
■ Selecting the Picture Size.....	27
■ Using the Digital NR (Noise Reduction) Feature	28
■ DNie™ (Digital Natural Image engine) DNie™	28
■ Setting the My Colour Control - (Easy Control)	29
■ Setting the My Colour Control - (Detail Control)	30

Symbols



Press



Important



Note

Contents (continued)

◆ USING YOUR TELEVISION (continued)	
■ Setting the Film Mode.....	31
■ Viewing the Picture In Picture (PIP)	32
■ Changing the Sound Standard	34
■ Adjusting the Sound Settings	35
■ Setting the SRS TSXT.....	35
■ Adjusting the Volume Automatically	36
■ Enjoying the Sound of External Speakers.....	37
■ Selecting the Sound Mode (depending on the model)	38
■ Setting and Displaying the Current Time.....	39
■ Setting the Sleep Timer.....	40
■ Switching the Television On and Off Automatically.....	41
■ Setting the Blue Screen.....	42
■ Setting the Melody Sound	42
■ Using the Colour Weakness Enhancement Feature	43
■ Setting the Picture in PC Mode	44
■ Viewing an External Signal Source	45
■ Assigning Names to External Sources	46
◆ USING THE TELETEXT FEATURE	
■ Teletext Feature	47
■ Displaying the Teletext Information	48
■ Selecting Display Options.....	48
■ Selecting a Teletext Page.....	49
◆ ADDITIONAL INFORMATION AND CONNECTIONS	
■ Connecting to the External Input/Output	50
■ Connecting to the Audio Output	51
■ Connecting to the S-Video Input.....	51
■ Connecting to the Digital Input	52
■ Connecting to the Component Input.....	53
■ Connecting to the PC Input	53
■ Setting up Your PC Software (Windows only)	54
■ PC/HDMI(DVI) Input Mode	55
■ Redirecting an Input to the External Output	56
◆ RECOMMENDATIONS FOR USE	
■ Setting Up Your Remote Control.....	57
■ Programming the Remote Control for Other Components	58
■ Replacing the Lamp.....	60
■ Troubleshooting: Before Contacting Service Personnel.....	61
■ Technical Specifications.....	62

Control Panel of Your Television

➤ The actual configuration on your TV may be different, depending on your model.

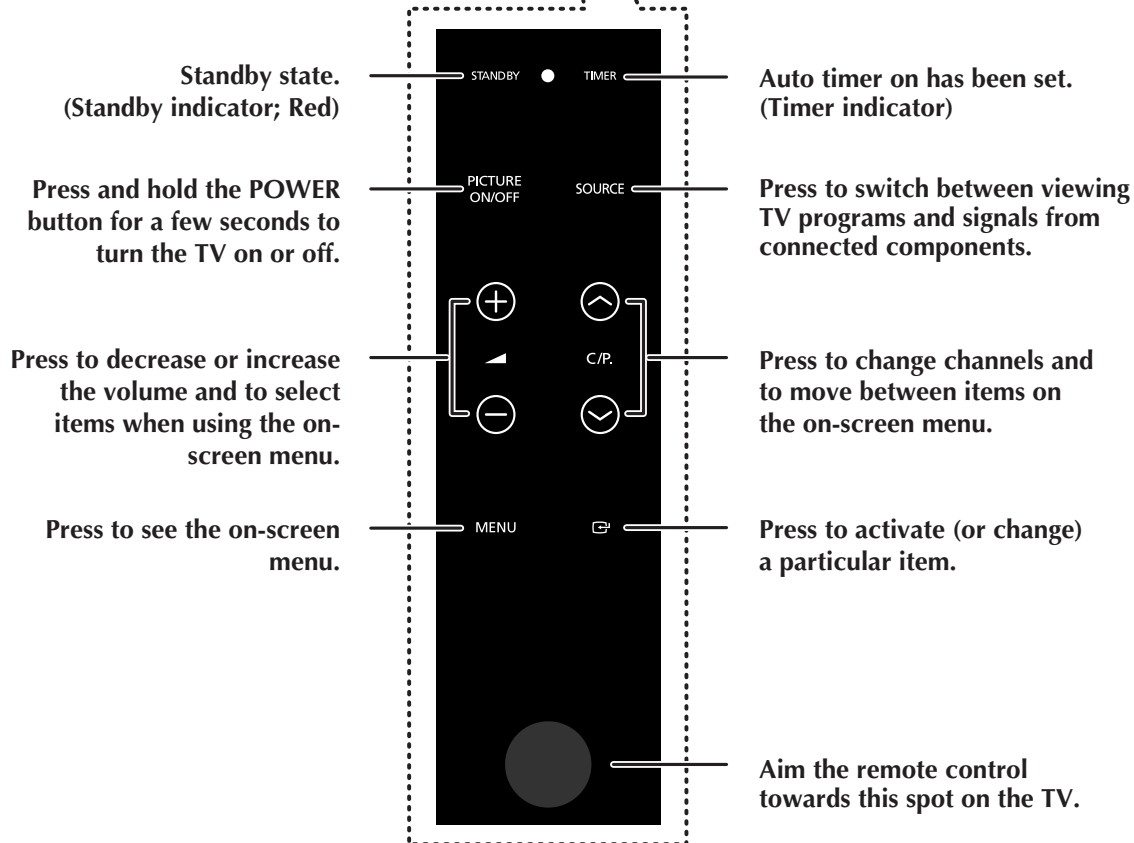
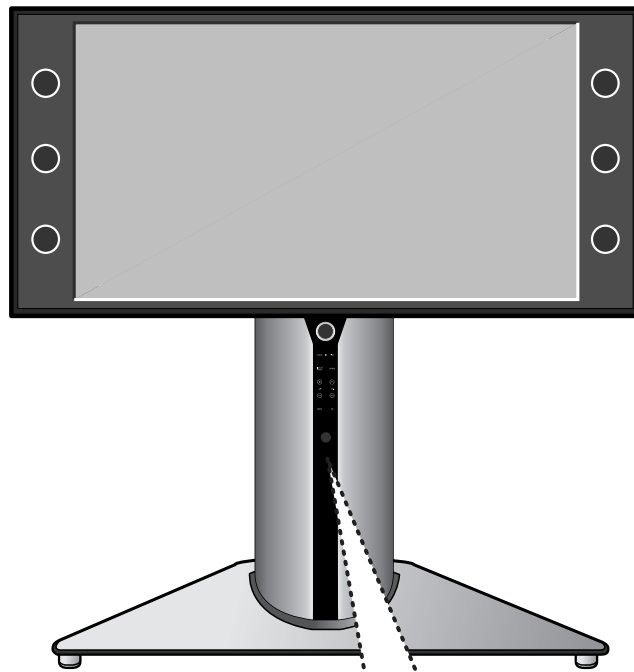

➤ Touching the control panel using your finger will light up Blue LEDs for all buttons. At this moment, locate the desired button and touch it to operate.

Connection Panel of Your Television

- The actual configuration on your TV may be different, depending on your model.

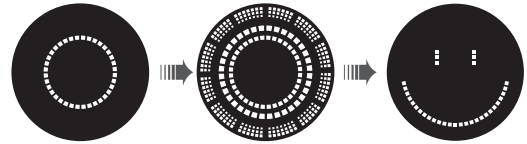
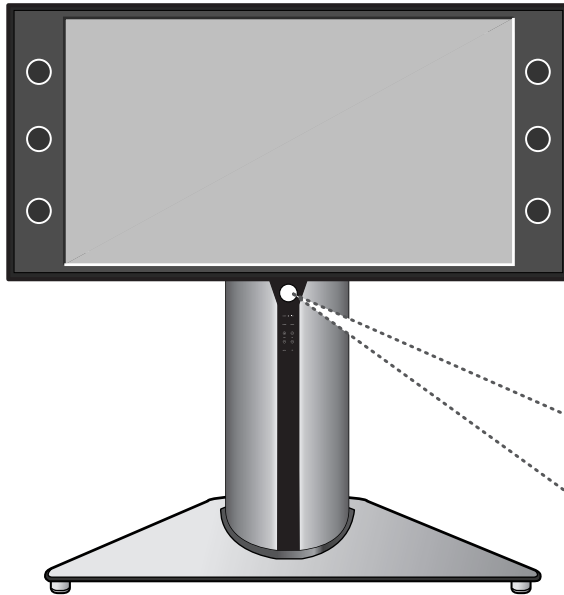

The Information window appears as illustrated above while the TV is turning on. (Refer to the TV set's display for animation details). When successfully turned on, an animated "Smile" figure appears and then fades out slowly.

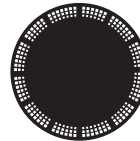

Appears while the TV is turning off.

When these indicators appear, there is a possible problem with the TV.



Lamp or other component may be defective. Please contact a certified technician.



Check if the ventilation hole on the rear of the set is blocked, because if the inner temperature is too high, the power will shut off.



A cooling fan inside the set is not operating normally.



The TV's rear cover is not properly shut.

- It takes about 30 seconds for the TV to warm up, so normal brightness may not appear immediately.
- The TV has a fan to keep the inside lamp from overheating. You'll occasionally hear it working.

Connection Panel of Your Television (continued)

- The actual configuration on your TV may be different, depending on your model.

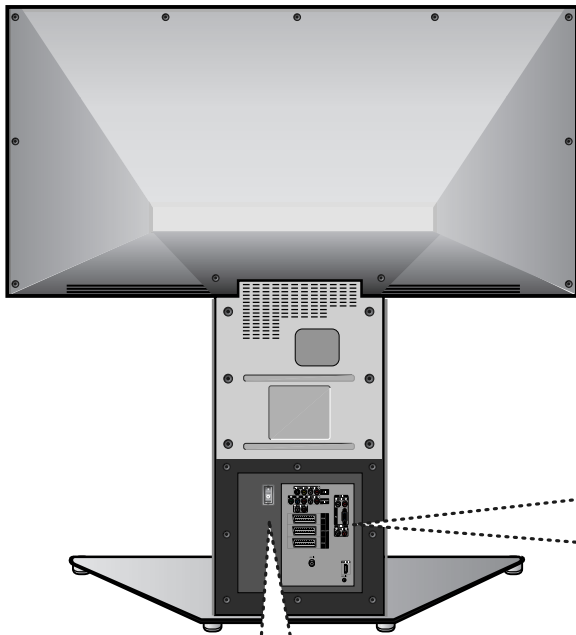

Switch the TV on and off
Press the power switch toward " I " (ON) to turn the TV on.

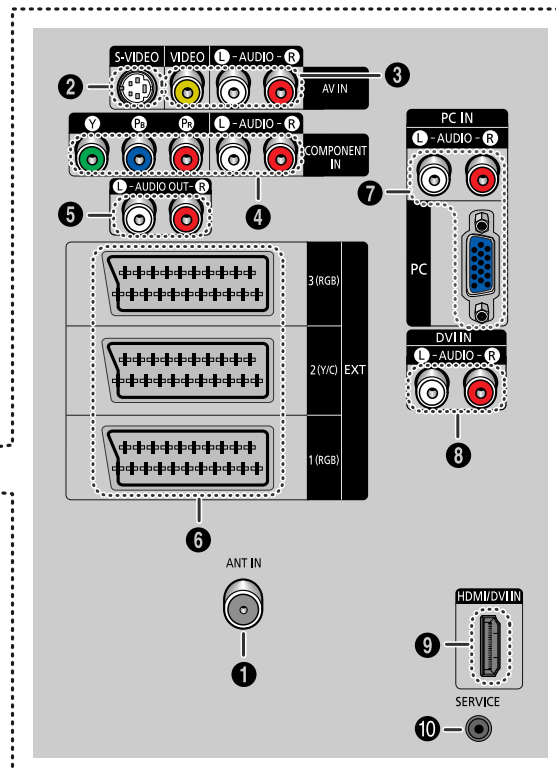

- 1 ANT IN**
Coaxial connector for aerial or cable network.
- 2 S-Video Input**
Connect to S-Video output jacks of an S-VHS VCR or DVD player.
- 3 Audio/Video Input**
Connect to the audio/video output jacks of VCRs, DVD players and similar devices.
- 4 COMPONENT Input**
Connect to the audio and video outputs of DVD or DTV Set-Top Box. 480i/480p/576i/576p/720p/1080i Y, Pb and Pr video signal outputs are available.
- 5 Audio Output**
Connect to the external audio amplifier.
- 6 SCART Input/Output**
Inputs or outputs for external devices, such as VCR, DVD, video game device or video disc players.
- 7 PC Input**
Connect to the PC audio/video outputs.
- 8 DVI Audio Input**
Connect to the audio output jacks for device with DVI output.
- 9 HDMI/DVI Input**
Connect to the digital device with HDMI or DVI output.
- 10 SERVICE Jack**
It is for repairs and software upgrades.

Connecting to an Aerial or Cable Television Network

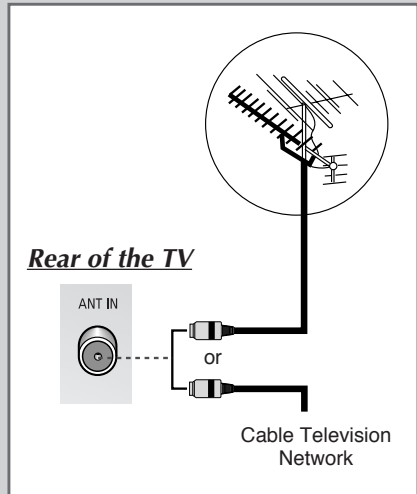

To view television channels correctly, a signal must be received by the set from one of the following sources:

- ◆ An outdoor aerial
- ◆ A cable television network
- ◆ A satellite network

- 1 In the first three cases, connect the aerial or network input cable to the ANT IN jack on the rear of the television.
- 2 If you are using an indoor aerial, you may need to turn it when tuning your television until you obtain a picture that is both sharp and clear.
For further details, refer to:
 - ◆ "Storing Channels Automatically" on page 15.
 - ◆ "Storing Channels Manually" on page 16.

Connecting a Satellite Receiver or Decoder

In order to watch television programmes broadcast via a satellite network, you must connect a satellite receiver to the rear of TV. Also, in order to descramble a coded transmission signal, you must connect a decoder to the rear of TV.

- ◆ **Using a RCA cable**
Connect the receiver (or decoder) RCA cable to one of the RCA connectors on the rear of the television.
 - ◆ **Using a coaxial cable**
Connect a coaxial cable to the:
 - Receiver (or Decoder) output socket.
 - Television aerial input socket.
- If you wish to connect both a satellite receiver (or decoder) and a VCR, you should connect the:
- ◆ Receiver (or Decoder) to the VCR
 - ◆ VCR to the television

Otherwise, connect the receiver (or decoder) directly to the television.

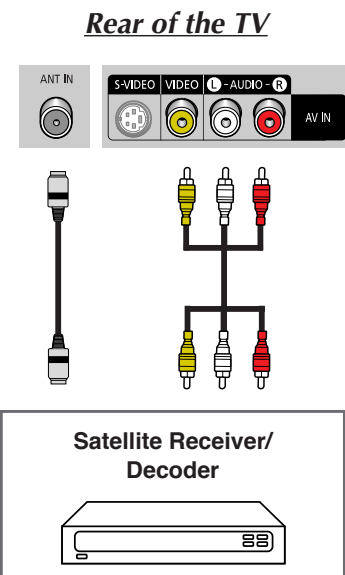

Infrared Remote Control

➤ The performance of the remote control may be affected by bright light.

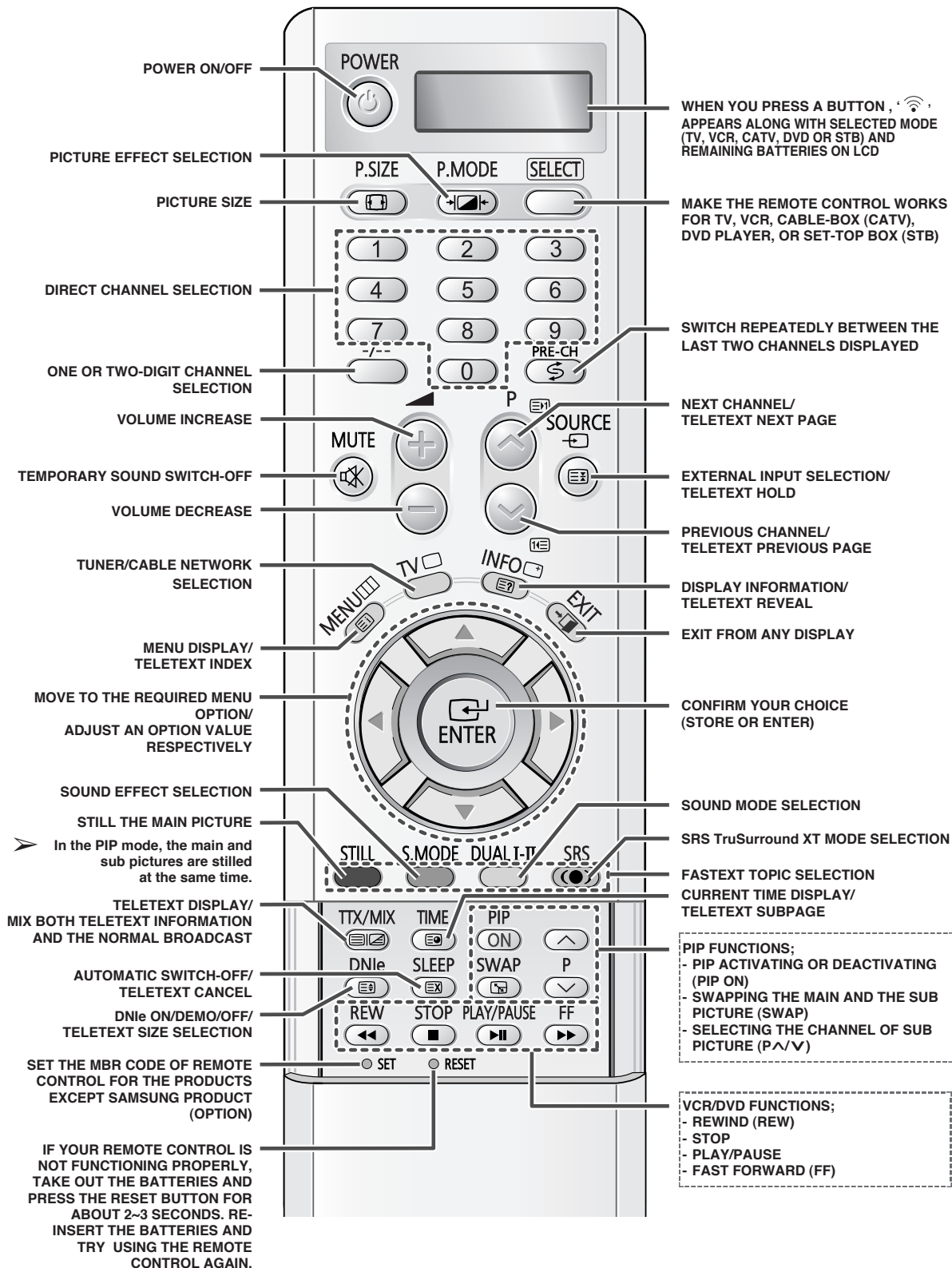

Inserting the Batteries in the Remote Control

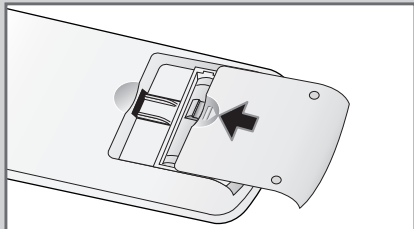
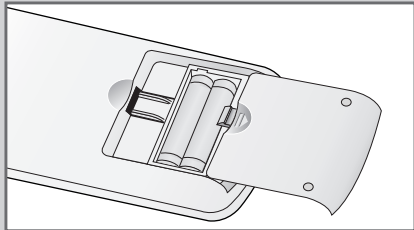
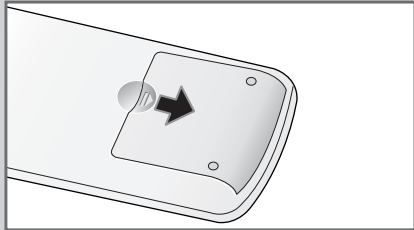

You must insert or replace the batteries in the remote control when you:

- ◆ *Purchase the television*
- ◆ *Find that the remote control is no longer operating correctly*

- 1 Remove the cover on the rear of the remote control by pressing the symbol (▼) downwards and then pulling firmly to remove it.
- 2 Insert two R03, UM4, "AAA" 1.5V or equivalent batteries taking care to respect the polarities:
 - ◆ - on the battery against - on the remote control
 - ◆ + on the battery against + on the remote control
- 3 Replace the cover by aligning it with the base of the remote control and pressing it back into place.
Do not mix battery types, i.e. alkaline and manganese.

Switching Your Television On and Off

The mains lead is attached to the rear of your television.

- 1 Plug the mains lead into an appropriate socket.
 - The main voltage is indicated on the rear of the television and the frequency is 50 or 60Hz.
- 2 Press the power switch on the rear of the television toward “ON” (I).
- 3 Press the **POWER** (⏻) button on the remote control or the front of the television.

Result: The programme that you were watching last is re-selected automatically.

 - If you have not yet stored any channels, No clear picture appears. Refer to “Storing Channels Automatically” on page 15 or “Storing Channels Manually” on page 16.
- 4 To switch your television off, press the power switch toward “OFF” (O).

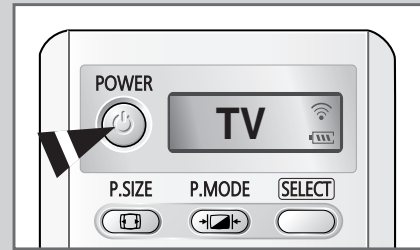
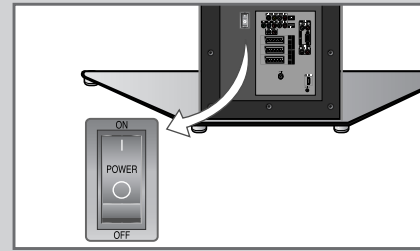

Placing Your Television in Standby Mode

Your television can be placed in Standby mode, in order to reduce the power consumption.

The Standby mode can be useful when you wish to interrupt viewing temporarily (during a meal, for example).

- 1 Press the **POWER** (⏻) button on the remote control.

Result: The screen is turned off and the Standby indicator on the front of the television lights.
 - 2 To turn the screen back on, simply press the **POWER** (⏻) button again.
 - You can also switch on by pressing the **P** (⏻) / **TV** or numeric button.
- 👉 Do not leave your television in Standby mode for long periods of time (when you are away on holiday, for example). Turn your television off by pressing the power switch on the back of the set. It is best to unplug the set from the mains and aerial.

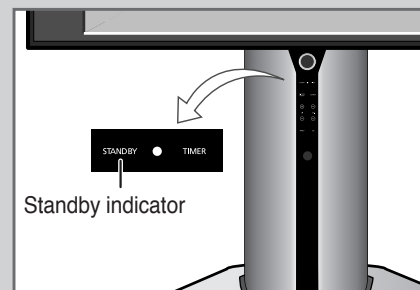
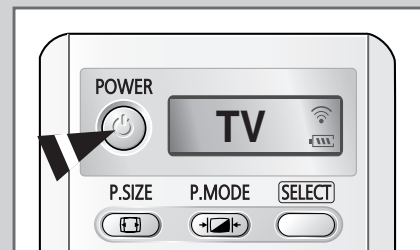

Becoming Familiar with the Remote Control

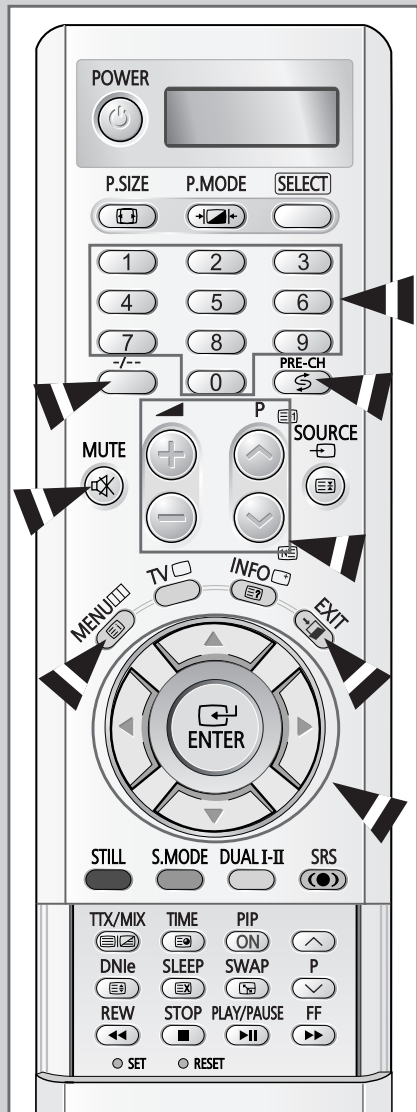

The remote control is used mainly to:

- ◆ Change channels and adjust the volume
- ◆ Display the on-screen menu system

The following table presents the most frequently used buttons and their functions.

Button	Viewing Function	Menu Function
	Used to display the next stored channel.	-
	Used to display the previous stored channel.	-
	Used to display the corresponding channels. ➤ For double digit channels, the second digit must be pushed immediately after the first. Failure to do this will result in a single digit channel being displayed.	
	Used to select a channel numbered ten or over. Press this button, and the "--" symbol is displayed. Enter the two-digit channel number.	
	Used to switch repeatedly between the last two channels displayed. To quickly switch between two channels that are far apart, tune to one channel, then use the numeric buttons to select second channel. Then, use the PRE-CH button to quickly alternate between them.	
	Used to increase the volume.	-
	Used to decrease the volume.	-
	Used to switch the sound off temporarily. ➤ To turn the sound back on, press this button again, or press the or button.	
	Used to display the on-screen menu system.	Used to return to the previous menu or normal viewing.
	-	Used to: ◆ Display a submenu containing selections for the current menu option ◆ Increase/decrease a menu option value
	-	Used to confirm your choice.
	-	Used to exit from the menu system and return to normal viewing directly.

Plug & Play Feature

When the television is initially powered ON, several basic customer settings proceed automatically and subsequently. The following settings are available.

- 1 If the television is in Standby mode, press the **POWER** (⏻) button on the remote control.
- 2 To start the Plug & Play, select the **Start** and press the **ENTER** button.
Result: The available languages are listed.
- 3 Select the appropriate language by pressing the ▲ or ▼ button. Press the **ENTER** button to confirm your choice.
Result: The message **Check antenna input** is displayed.
- 4 Make sure that the antenna is connected to the TV, and then press the **ENTER** button.
Result: The available areas are listed.
- 5 Select the appropriate area by pressing the ▲ or ▼ button. Press the **ENTER** button to confirm your choice.
Result: The **Auto Store** menu is displayed.
- 6 Press the **ENTER** button to start the search
Result: The search will end automatically. Channels are sorted and stored in an order which reflects their position in the frequency range (with lowest first and highest last).
➤ To stop the search before it has finished or return to normal viewing, press the **EXIT** or **ENTER** button.
- 7 When the channels have been stored, the **Clock Set** menu is displayed. Press the **ENTER** button to set the current time. Press the ◀ or ▶ button to move to the hour or minute. Set these by pressing the ▲ or ▼ button. Press the **ENTER** button to confirm your choice.
- 8 When it has finished, the message **Enjoy your watching** is displayed, and then the channel which has been stored will be activated.

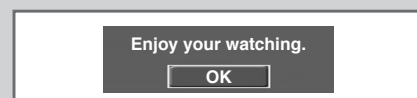
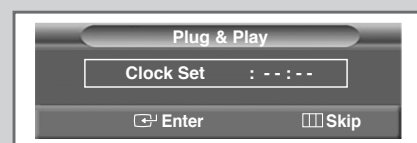

Plug & Play Feature (continued)

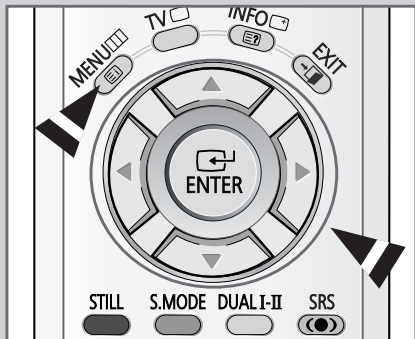

If you want to reset this feature...

- 1 Press the **MENU** button.
Result: The main menu is displayed.
- 2 Press the **▲** or **▼** button to select **Setup**.
Result: The options available in the **Setup** group are displayed.
- 3 Press the **ENTER** button.
Result: The **Plug & Play** is selected.
- 4 Press the **ENTER** button again.
- 5 To start the Plug & Play, select the **Start** and press the **ENTER** button.
- 6 For further details on how to set, refer to the previous page.

Choosing Your Language



When you start using your television for the first time, you must select the language which will be used for displaying menus and indications.

- 1 Press the **MENU** button.
Result: The main menu is displayed.
- 2 Press the **▲** or **▼** button to select **Setup**.
Result: The options available in the **Setup** group are displayed.
- 3 Press the **ENTER** button.
- 4 Press the **▲** or **▼** button to select **Language**. Press the **ENTER** button.
Result: The available languages are listed.
- 5 Select the appropriate language by pressing the **▲** or **▼** button.
- 6 Press the **ENTER** button to confirm your choice.

Storing Channels Automatically

You can scan for the frequency ranges available to you (and availability depends on your country). Automatically allocated programme numbers may not correspond to actual or desired programme numbers. However you can sort numbers manually and clear any channels you do not wish to watch.

- 1 Press the **MENU** button.
Result: The main menu is displayed.
- 2 Press the **▲** or **▼** button to select **Channel**.
Result: The options available in the **Channel** group are displayed.
- 3 Press the **ENTER** button.
Result: The **Auto Store** is selected.
- 4 Press the **ENTER** button again.
Result: The **Area** is selected.
- 5 Press the **ENTER** button once again.
Result: The available areas are listed.
- 6 Select the appropriate area by pressing the **▲** or **▼** button.
Press the **ENTER** button to confirm your choice
- 7 Press the **▲** or **▼** button to select **Search**.
Press the **ENTER** button.
- 8 To start the search, select the **Start** and press the **ENTER** button.
Result: The search will end automatically. Channels are sorted and stored in an order which reflects their position in the frequency range (with lowest first and highest last). The programme originally selected is then displayed.
➤ To stop the search before it has finished or return to normal viewing, press the **EXIT** or **ENTER** button.
- 9 When the channels have been stored, you can:
 - ◆ Sort them in the order required (see page 19)
 - ◆ Clear a channel (see page 18)
 - ◆ Assign a name to the stored channels (see page 21)
 - ◆ Fine-tune channel reception if necessary (see page 22)
 - ◆ Activate/deactivate the **LNA** (Low Noise Amplifier) feature (see page 23)
 - ◆ Activate/deactivate the **Digital NR** (Noise Reduction) feature (see page 28)

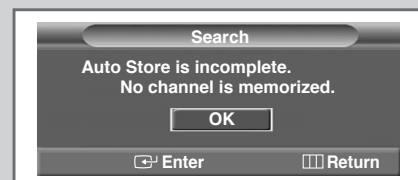
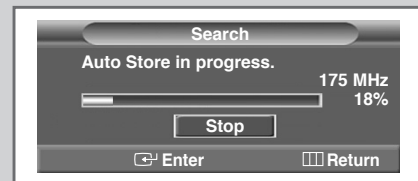
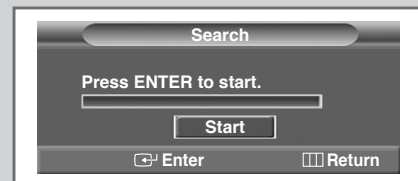

Storing Channels Manually

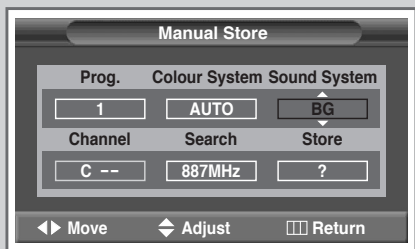
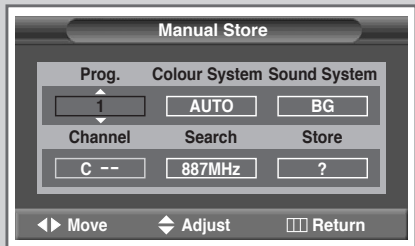

You can store the television channels, including those received via cable networks.

When storing channels manually, you can choose:

- ◆ Whether or not to store each of the channels found
- ◆ The programme number of each stored channel which you wish to identify

1 Press the **MENU** button.

Result: The main menu is displayed.

2 Press the **▲** or **▼** button to select **Channel1**.

Result: The options available in the **Channel1** group are displayed.

3 Press the **ENTER** button.

4 Press the **▲** or **▼** button to select **Manual Store**. Press the **ENTER** button.

Result: The option available in the **Manual Store** group are displayed with **Prog.** is selected.

5 To assign a programme number to a channel, find the correct number by pressing the **▲** or **▼** button.

6 If necessary, select the broadcasting standard required. Press the **◀** or **▶** button to select **Colour System** and press the **▲** or **▼** button. The colour standards are displayed in the following order. (depending on the model).

◆ **AUTO - PAL - SECAM**

7 Press the **◀** or **▶** button to select **Sound System** and press the **▲** or **▼** button. The sound standards are displayed in the following order. (depending on the model).

BG - DK - I - L

Storing Channels Manually (continued)

- 8 If you know the number of the channel to be stored, see the following steps.
- ◆ Press the ◀ or ▶ button to select **Channel**.
 - ◆ Press the ▲ or ▼ button to select **C** (Air channel) or **S** (Cable channel).
 - ◆ Press the ▶ button.
 - ◆ Press the numeric buttons (0~9), ▲ or ▼ button to select indicate the required number.
- If there is no sound or abnormal sound, reselect the sound standard required.

- 9 If you do not know the channel numbers, select the **Search** by pressing the ◀ or ▶ button. Press the ▲ or ▼ button to start the search.

Result: The tuner scans the frequency range until the first channel or the channel that you selected is received on your screen.

- 10 To store the channel and associated programme number, select the **Store** by pressing the ◀ or ▶ button. Press the **ENTER** button.

Result: The **OK** is displayed.

- 11 Repeat Steps 8 to 10 for each channel to be stored.



Channel mode

- ◆ **P** (Programme mode): When completing tuning, the broadcasting stations in your area have been assigned to position numbers from P00 to P99. You can select a channel by entering the position number in this mode.
- ◆ **C** (Real channel mode): You can select a channel by entering the assigned number to each air broadcasting station in this mode.
- ◆ **S** (Cable channel mode): You can select a channel by entering the assigned number for each cable channel in this mode.

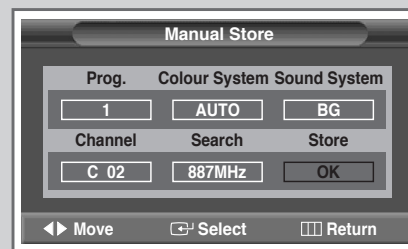
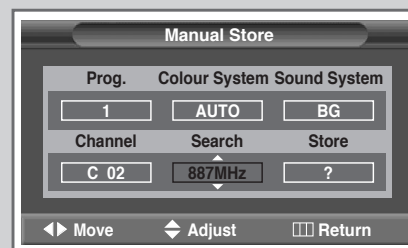
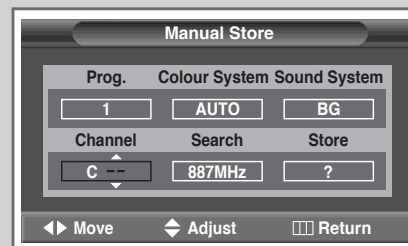
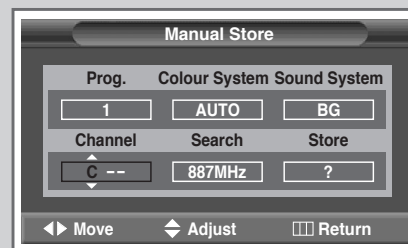

Skipping Unwanted Channels

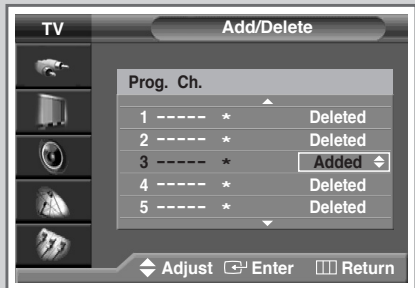

You can exclude the channels of your choice from the channel scan operation. When you scan through the stored channels, those that you have chosen to skip are thus not displayed. All channels that you do not specifically choose to skip are displayed during scanning.

- 1 Press the **MENU** button.
Result: The main menu is displayed.
- 2 Press the **▲** or **▼** button to select **Channel**.
Result: The options available in the **Channel** group are displayed.
- 3 Press the **ENTER** button.
- 4 Press the **▲** or **▼** button to select **Add/Delete**.
Press the **ENTER** button.
Result: The **Add/Delete** menu is displayed with the current channel automatically is selected.
- 5 Press the **▲** or **▼** button to select the channel to be added or deleted. Press the **ENTER** button.
- 6 To add or delete the channel, select **Added** or **Deleted** by pressing the **▲** or **▼** button.
- 7 Press the **ENTER** button to confirm.

Sorting the Stored Channels

This operation allows you to change the programme numbers of stored channels. This operation may be necessary after using the auto store. You can delete those channels you do not want to keep.

- 1 Press the **MENU** button.
Result: The main menu is displayed.
- 2 Press the **▲** or **▼** button to select **Channel**.
Result: The options available in the **Channel** group are displayed.
- 3 Press the **ENTER** button.
- 4 Press the **▲** or **▼** button to select **Sort**. Press the **ENTER** button.
Result: The **Sort** menu is displayed.
- 5 Select the channel that you wish to move by pressing the **▲** or **▼** button. Press the **ENTER** button.
- 6 Select the number of the programme to which the channel is to be moved by pressing the **▲** or **▼** button. Press the **ENTER** button.
Result: The channel is moved to its new position and all other channels are shifted accordingly.
- 7 Repeat Steps 5 to 6 until you have moved all the channels to the required programme numbers.

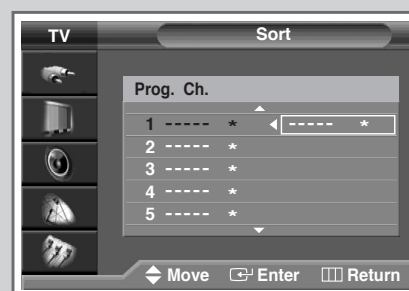
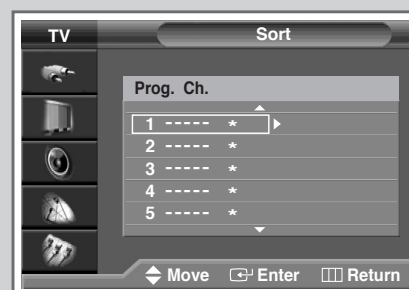

Activating the Child Lock



This feature allows you to prevent unauthorized users, such as children, from watching unsuitable programmes by muting out video and audio. Child Lock cannot be released using front panel buttons. Only remote control can release the Child Lock setting, so keep the remote control away from children.

1 Press the **MENU** button.

Result: The main menu is displayed.

2 Press the **▲** or **▼** button to select **Channel**.

Result: The options available in the **Channel** group are displayed.

3 Press the **ENTER** button.

4 Press the **▲** or **▼** button to select **Child Lock**.
Press the **ENTER** button.

Result: The **Child Lock** menu is displayed with the current channel automatically is selected.
Blue Screen is displayed when the **Child Lock** is activated.

5 Press the **▲** or **▼** button to select the channel to be locked.

6 Press the **ENTER** button. To lock the channel, select **Locked** by pressing the **▲** or **▼** button (to unlock the channel, select **Unlocked**).

7 Press the **ENTER** button to confirm.

Assigning Names to Channels

Channel names will be assigned automatically when channel information is broadcast. These names can be changed, allowing you to assign new names.

- 1 Press the **MENU** button.
Result: The main menu is displayed.
- 2 Press the **▲** or **▼** button to select **Channel**.
Result: The options available in the **Channel** group are displayed.
- 3 Press the **ENTER** button.
- 4 Press the **▲** or **▼** button to select **Name**. Press the **ENTER** button.
Result: The **Name** menu is displayed with the current channel automatically is selected.
- 5 If necessary, select the channel to be assigned to a new name by pressing the **▲** or **▼** button. Press the **ENTER** button.
Result: Arrow indications are displayed around the name box.
- 6 Press the **▲** or **▼** button to select a letter (A~Z), a number (0~9) or a symbol (space, ., -). Move on to the previous or next letter by pressing the **◀** or **▶** button.
- 7 Repeat Steps 5 to 6 for each channel to be assigned to a new name.
- 8 When you have finished entering the name, press the **ENTER** button to confirm the name.

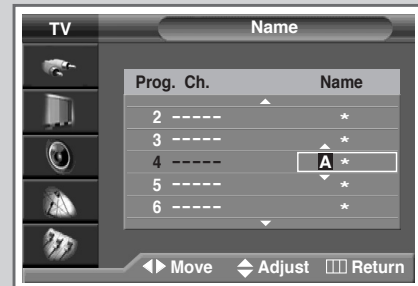
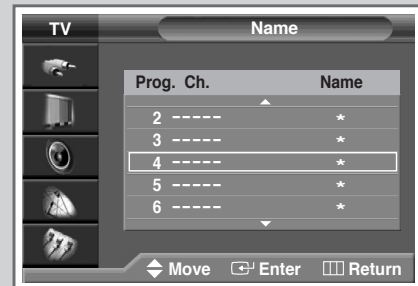

Fine Tuning Channel Reception

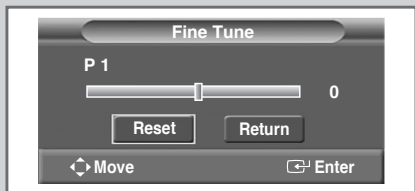
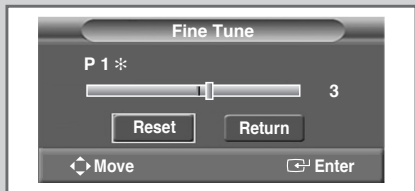
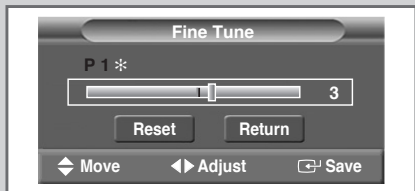
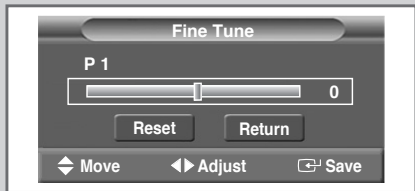

If the reception is clear, you do not have to fine tune the channel, as this is done automatically during the search and store operation. If the signal is weak or distorted, you may have to fine tune the channel manually.

- 1 Press the **MENU** button.

Result: The main menu is displayed.

- 2 Press the **▲** or **▼** button to select **Channel**.

Result: The options available in the **Channel** group are displayed.

- 3 Press the **ENTER** button.

- 4 Press the **▲** or **▼** button to select **Fine Tune**. Press the **ENTER** button.

Result: The horizontal bar is displayed.

- 5 To obtain a sharp and clear picture and good sound quality, press the **◀** or **▶** button until you reach the required setting.

- 6 To store the fine tuning setting in the TV's memory, press the **ENTER** button.

Result: The symbol “*” is displayed beside the programme number.

- 7 To reset the fine tuning to **0**, select **Reset** by pressing the **▲** or **▼** button then press the **ENTER** button.

Using the LNA (Low Noise Amplifier) Feature

This function is very useful in the situation that the TV is used in weak signal. LNA amplifies the TV signal in the weak signal area, but not noise.

This feature is working only in a weak signal condition, and that is memorized on relevant channel's additional information.

- 1 Press the **MENU** button.
Result: The main menu is displayed.
- 2 Press the **▲** or **▼** button to select **Channel**.
Result: The options available in the **Channel** group are displayed.
- 3 Press the **ENTER** button.
- 4 Press the **▲** or **▼** button to select **LNA**. Press the **ENTER** button.
- 5 Select **off** or **on** by pressing the **▲** or **▼** button.
- 6 Press the **ENTER** button to confirm.

-
- ◆ If the picture is noisy with the **LNA** set to **On**, select **Off**.
 - ◆ LNA setting is to be made for each channel.



Viewing the Channel Scan Picture

This feature automatically scans all of the channels it has memorized.

- 1 Press the **MENU** button.
Result: The main menu is displayed.
- 2 Press the **▲** or **▼** button to select **Channel**.
Result: The options available in the **Channel** group are displayed.
- 3 Press the **ENTER** button.
- 4 Press the **▲** or **▼** button to select **Scan**. Press the **ENTER** button.
Result: You can view every memorized channel in order through the sub picture. When viewing has finished or stopped, the PIP feature will be activated.

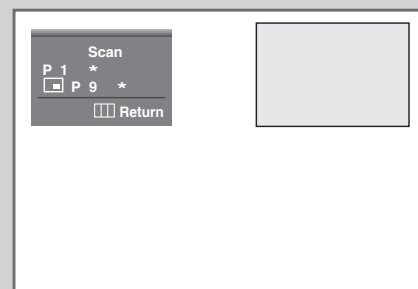
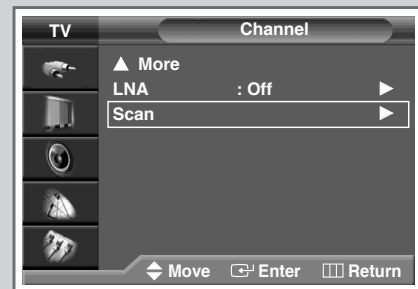

Displaying Information



*You can view the channel information and setting status you select by pressing the “INFO ” button on the remote control.
The information displayed varies according to the selected source.*

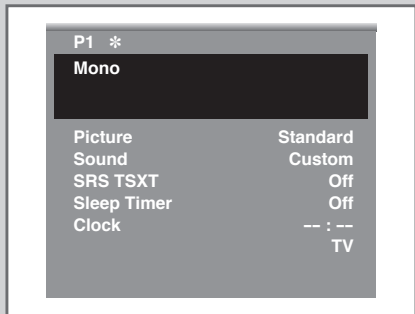

Freezing the Current Picture

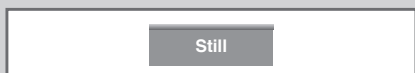
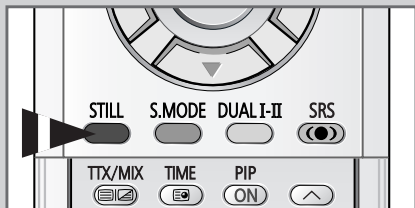

You can freeze the picture when watching a television programme simply by pressing the “STILL” button. To return to normal viewing, press it again.

- In the PIP mode, the main and sub pictures are stilled at the same time.

Changing the Picture Standard

You can select the type of picture which best corresponds to your viewing requirements.

- 1 Press the **MENU** button.
Result: The main menu is displayed.
- 2 Press the **▲** or **▼** button to select **Picture**.
Result: The options available in the **Picture** group are displayed.
- 3 Press the **ENTER** button.
Result: The **Mode** is selected.
- 4 Press the **ENTER** button again.
Result: The options available are displayed with the **Mode** is selected.
- 5 Press the **ENTER** button once again. Select the required option by pressing the **▲** or **▼** button.
Result: The following modes are available.
Dynamic - Standard - Cinema
- 6 Press the **ENTER** button to confirm.

➤ You can also select these options simply by pressing the **P.MODE** (Picture Mode) button.

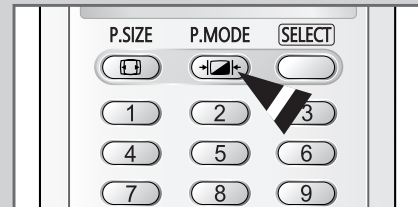
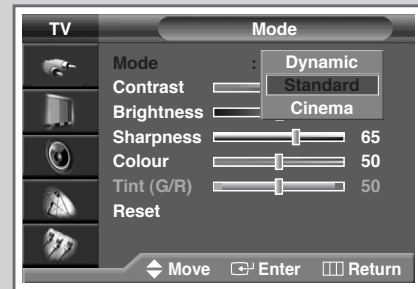
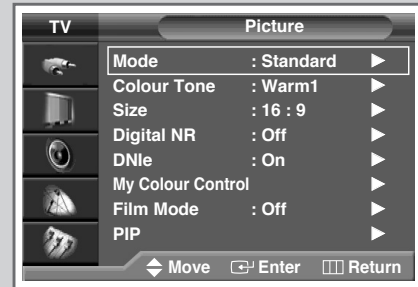

Adjusting the Picture Settings

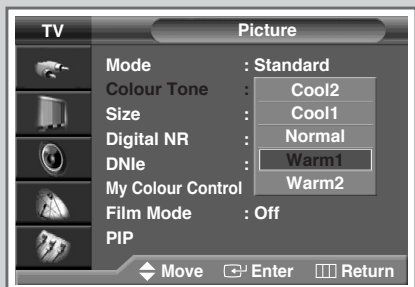
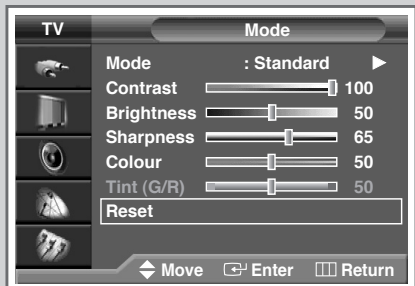
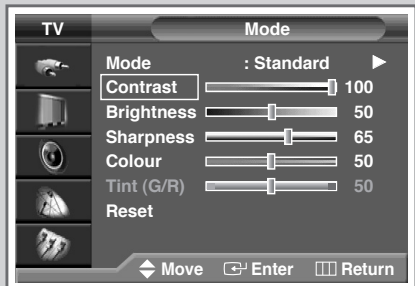
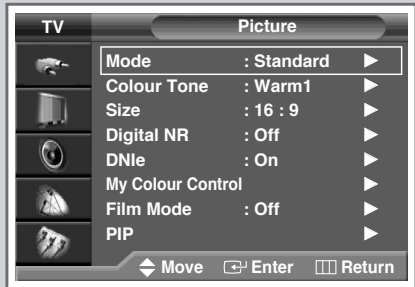

Your television has several settings which allow you to control picture quality.

- 1 Press the **MENU** button.
Result: The main menu is displayed.
- 2 Press the **▲** or **▼** button to select **Picture**.
Result: The options available in the **Picture** group are displayed.
- 3 Press the **ENTER** button.
Result: The **Picture** is selected.
- 4 Press the **ENTER** button again.
Result: The options available are displayed with the **Mode** is selected.
- 5 Select the required option (**Contrast**, **Brightness**, **Sharpness**, **Colour** or **Tint (G/R)**-NTSC only) by pressing the **▲** or **▼** button. Press the **ENTER** button.
➤ The options are adjustable in each mode (**Dynamic**, **Standard** or **Cinema**).
- 6 Press the **◀** or **▶** button until you reach the required setting. Press the **ENTER** button.
Result: The **Mode** menu is displayed again.
- 7 To reset the picture settings to the factory defaults, select **Reset** by pressing the **▲** or **▼** button. Press the **ENTER** button.
Result: The previously adjusted picture settings will be reset to the factory defaults.
- 8 Press the **MENU** button.
Result: The options available in the **Picture** group are displayed again.
- 9 Press the **▲** or **▼** button to select **Colour Tone**. Press the **ENTER** button.
- 10 Select the required option by pressing the **▲** or **▼** button.
Result: The following modes are available.
Cool2 - Cool1 - Normal - Warm1 - Warm2
- 11 Press the **ENTER** button to confirm.

Selecting the Picture Size

You can select the picture size which best corresponds to your viewing requirements.

- 1 Press the **MENU** button.
Result: The main menu is displayed.

- 2 Press the **▲** or **▼** button to select **Picture**.
Result: The options available in the **Picture** group are displayed.

- 3 Press the **ENTER** button.

- 4 Press the **▲** or **▼** button to select **Size**. Press the **ENTER** button.
Result: The following modes are available depending on the model.
 - ◆ **Auto Wide - 16:9 - Panorama - Zoom1 - Zoom2 - 14:9 - 4:3**
 - Lifting is available in the **Zoom1**, **Zoom2** or **14:9** mode by pressing the **▲** or **▼** button.
 - ◆ **Auto Wide** : Expanding and pulling up the picture from 4:3 to 16:9 ratio.
 - ◆ **16:9** : Sets the picture to 16:9 wide mode.
 - ◆ **Panorama** : Use this mode for the wide aspect ratio of a panoramic picture.
 - ◆ **Zoom** : Magnify the size of the picture vertically on screen.
 - ◆ **14:9** : Magnify the size of the picture more than 4:3.
 - ◆ **4:3** : Sets the picture to 4:3 normal mode.

- 5 Select the required mode by pressing the **▲** or **▼** button. Press the **ENTER** button.

- ◆ You can select these option by simply pressing the P.SIZE button on the remote control.
- ◆ You can not select Panorama screen size in the Component mode.
- ◆ You can select only 16:9, 4:3 screen size in the PC or HDMI mode.
- ◆ With PIP On, the screen automatically becomes 16:9 screen size.
- ◆ PIP will disappear automatically when you change screen size with PIP on.

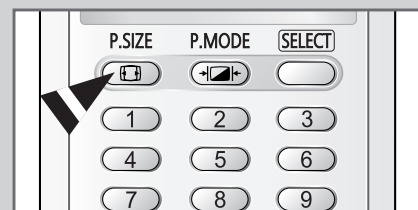
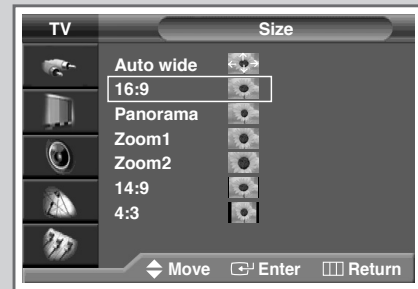
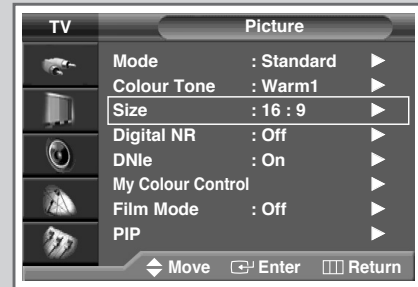

Using the Digital NR (Noise Reduction) Feature

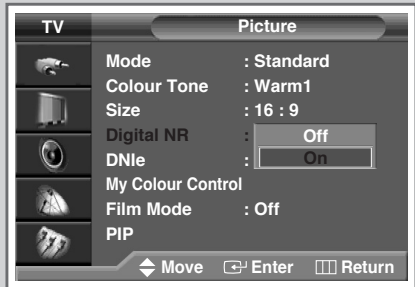

If the signal received by your television is weak, you can activate this feature to help reduce any static and ghosting that may appear on the screen.

- 1 Press the **MENU** button.
Result: The main menu is displayed.
- 2 Press the **▲** or **▼** button until the **Picture** is selected.
Result: The options available in the **Picture** group are displayed.
- 3 Press the **ENTER** button.
- 4 Press the **▲** or **▼** button until the **Digital NR** is selected.
Press the **ENTER** button.
- 5 Select **off** or **on** by pressing the **▲** or **▼** button.
- 6 Press the **ENTER** button to confirm.

DNle™ (Digital Natural Image engine) DNle™

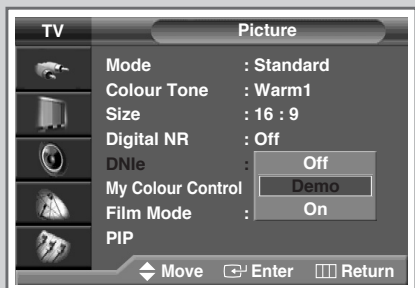

This feature brings you a more detailed image with 3D noise reduction and detail, contrast and white enhancement.



- 1 Press the **MENU** button.
Result: The main menu is displayed.
- 2 Press the **▲** or **▼** button to select **Picture**.
Result: The options available in the **Picture** group are displayed.
- 3 Press the **ENTER** button.
- 4 Press the **▲** or **▼** button to select **DNle**. Press the **ENTER** button.
- 5 Press the **▲** or **▼** button to change the setting.
 - ◆ **off** Switches off the DNle mode.
 - ◆ **Demo** The screen before applying DNle appears on the right and the screen after applying DNle appears on the left.
 - ◆ **On** Switches on the DNle mode.
- 6 Press the **ENTER** button to confirm.

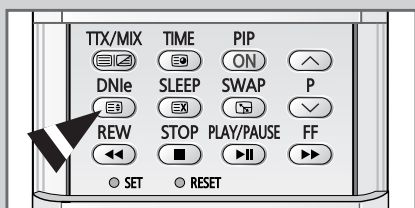

➤ You can select these options simply by pressing the **DNle** button.

Setting the My Colour Control (Easy Control)

This feature allows you to adjust colours according to their preferences, by adjusting skin, sky and grass tones using the predefined settings (“Blue”, “Green”, “Pink”, “Standard”, “Custom”) without affecting other colours on the screen.

- 1 Press the **MENU** button.
Result: The main menu is displayed.
 - 2 Press the **▲** or **▼** button to select **Picture**.
Result: The options available in the **Picture** group are displayed.
 - 3 Press the **ENTER** button.
 - 4 Press the **▲** or **▼** button to select **My Colour Control**. Press the **ENTER** button.
Result: The options available are displayed with the **Easy Control** is selected.
 - 5 Press the **ENTER** button.
Result: The following modes are available:
 - ◆ **Blue**
Emphasizes Clear Blues.
 - ◆ **Green**
Emphasizes Mild Greens.
 - ◆ **Pink**
Emphasizes Warm Skin Colours.
 - ◆ **Standard**
Standard Picture
 - ◆ **Custom**
Changing the settings in the **Detail Control** menu will automatically set to **Custom** (see next page).
 - 6 Select the required mode by pressing the **◀** or **▶** button.
Result: The original picture (before adjustment) is shown on the left side, while the selected mode is shown on the right side.
 - 7 Press the **ENTER** button to confirm.
- ◆ Depending on the input source(PC format signal of PC or HDMI mode), this feature may not operate.
- ◆ This feature is operated when the “DNIe” is set to “On” or “Demo” mode.

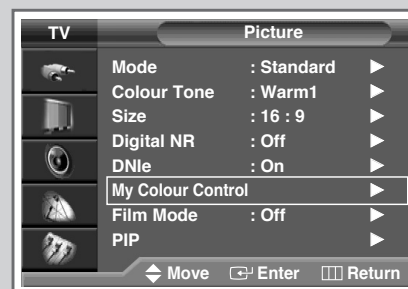

Setting the My Colour Control (Detail Control)

This settings can be adjusted to suit your personal preferences.

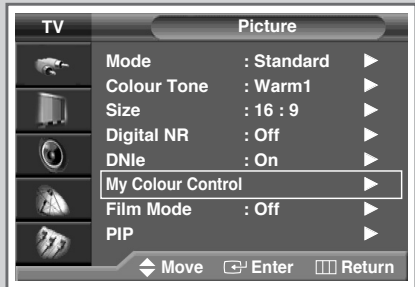

- 1 Press the **MENU** button.
Result: The main menu is displayed.
- 2 Press the **▲** or **▼** button to select **Picture**.
Result: The options available in the **Picture** group are displayed.
- 3 Press the **ENTER** button.
- 4 Press the **▲** or **▼** button to select **My Colour Control**. Press the **ENTER** button.
- 5 Press the **▲** or **▼** button to select **Detail Control**. Press the **ENTER** button.
Result: The available options are displayed.
- 6 Select the required option (**Pink**, **Green** or **Blue**) by pressing the **▲** or **▼** button. Press the **ENTER** button.
- 7 Press the **◀** or **▶** button until you reach the required setting.
Result: Changing the adjustment value will refresh the adjusted screen.
- 8 Press the **MENU** button.
Result: The options available in the **Detail Control** group are displayed again.
- 9 To return the factory defaults, select **Reset** by pressing the **▲** or **▼** button.
Result: The previously adjusted colours will be reset to the factory defaults.
- 10 Press the **ENTER** button.

Setting the Film Mode

You can automatically sense and process film signals from all sources and adjust the picture for optimum quality.

- 1 Press the **MENU** button.
Result: The main menu is displayed.
- 2 Press the **▲** or **▼** button to select **Picture**.
Result: The options available in the **Picture** group are displayed.
- 3 Press the **ENTER** button.
- 4 Press the **▲** or **▼** button to select **Film Mode**.
Press the **ENTER** button.
- 5 Select **off** or **on** by pressing the **▲** or **▼** button.
 - ◆ **off** Switches off the film mode.
 - ◆ **on** Automatically senses and processes film signals from all sources and adjusts the picture for optimum quality.
- 6 Press the **ENTER** button to confirm.

➤ Not available in the Component (480p/576p/720p/1080i), PC, HDMI or DVI mode.

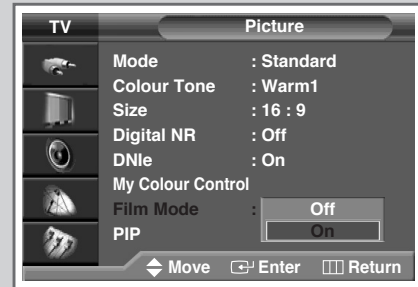

Viewing the Picture In Picture (PIP)

You can display a sub picture within the main picture of TV program or external A/V devices. In this way you can watch TV program or monitor the video input from any connected devices while watching TV or other video input.

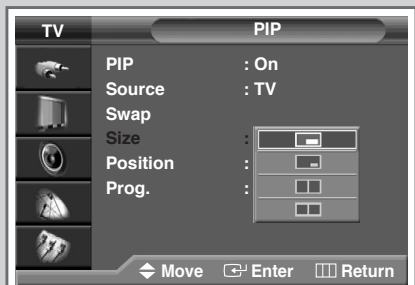
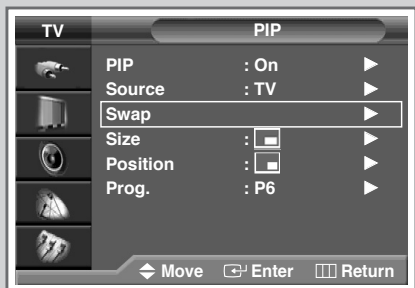
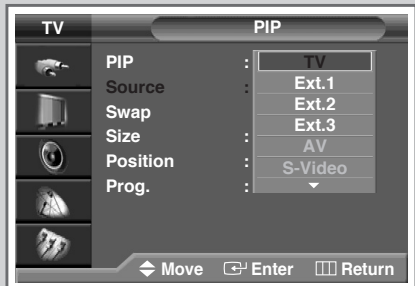
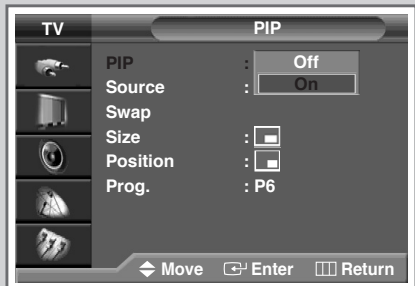
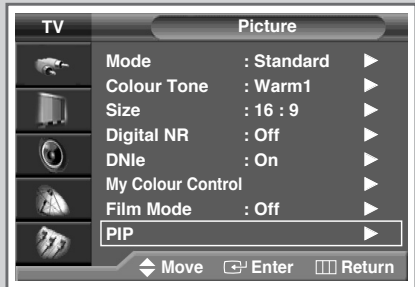

1 Press the **MENU** button.

Result: The main menu is displayed.

2 Press the **▲** or **▼** button to select **Picture**.

Result: The options available in the **Picture** group are displayed.

3 Press the **ENTER** button.

4 Press the **▲** or **▼** button to select **PIP**. Press the **ENTER** button.

Result: The **PIP** is selected.

5 Press the **ENTER** button again. To activate, set the **PIP** to **On** by pressing the **▲** or **▼** button. Press the **ENTER** button.

6 Press the **▲** or **▼** button to select **Source**. Press the **ENTER** button. Select a source of the sub picture by pressing the **▲** or **▼** button.

Result: The available sources are displayed:

TV - Ext.1 - Ext.2 - Ext.3 - AV - S-Video - Component - PC - HDMI

➤ When the main picture is in the **Component**, **PC** or **HDMI** mode, only the **TV**, **Ext.1**, **Ext.2**, **Ext.3**, **AV** or **S-Video** sources available.

7 Press the **ENTER** button.

8 Press the **▲** or **▼** button to select **Swap**. Press the **ENTER** button.

Result: The main picture and sub picture are interchanged.

9 Press the **▲** or **▼** button to select **Size**. Press the **ENTER** button. Select a size of the sub picture by pressing the **▲** or **▼** button.

Result: The available sizes are displayed:



10 Press the **ENTER** button.

Viewing the Picture In Picture (PIP) (continued)

- 11 Press the ▲ or ▼ button to select **Position**. Press the **ENTER** button. Select a position of the sub picture by pressing the ▲ or ▼ button.

Result: The available positions are displayed:



- Position can not be selected in the “” (Double1) or “” (Double2) picture size mode.

- 12 Press the **ENTER** button.

- 13 Press the ▲ or ▼ button to select **Prog.**. Press the **ENTER** button. Select the channel that you want to view through sub picture by pressing the ▲ or ▼ button.

- 14 Press the **ENTER** button.

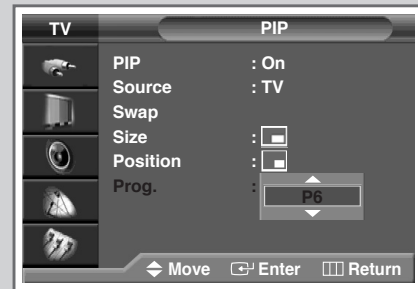
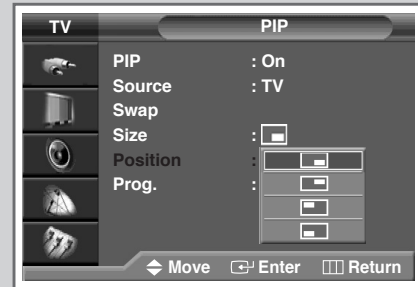

Easy functions of remote control.

Buttons	Feature
PIP	Used to activate or deactivate the PIP function directly.
SWAP	Used to interchange the main picture and the sub picture. ➤ When the main picture is in the Video mode and the sub picture is in the TV mode, you might not hear the sound of main picture when pressing the SWAP button after changing the sub picture channel. At this time, reselect the channel of main picture.
P▲/▼	Used to select the channel of sub picture.

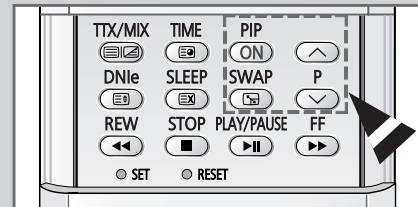

Changing the Sound Standard

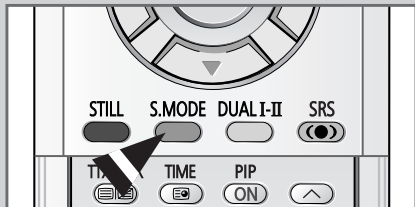
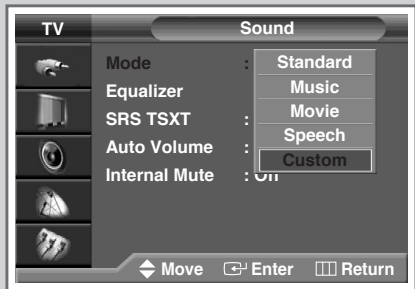
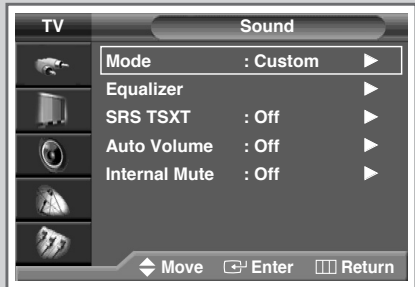

You can select the type of special sound effect to be used when watching a given broadcast.

1 Press the **MENU** button.

Result: The main menu is displayed.

2 Press the **▲** or **▼** button to select **Sound**.

Result: The options available in the **Sound** group are displayed.

3 Press the **ENTER** button.

Result: The **Mode** is selected.

4 Press the **ENTER** button again.

5 Select the option by pressing the **▲** or **▼** button.
The sound effects are displayed in the following order.

Standard - Music - Movie - Speech - Custom

6 Press the **ENTER** button to confirm.

➤ You can also set these options simply by pressing the **S.MODE** (Sound Mode) button.

Adjusting the Sound Settings

The sound settings can be adjusted to suit your personal preferences.

- 1 Press the **MENU** button.
Result: The main menu is displayed.
- 2 Press the **▲** or **▼** button to select **Sound**.
Result: The options available in the **Sound** group are displayed.
- 3 Press the **ENTER** button.
- 4 Press the **▲** or **▼** button to select **Equalizer**.
Press the **ENTER** button.
Result: The **Equalizer** menu is displayed with the current option.
- 5 Select the option to be adjusted by pressing the **◀** or **▶** button.
Press the **▲** or **▼** button until you reach the required setting.
- 6 Press the **ENTER** button to confirm.

- If you make any changes to the equalizer settings, the sound standard is automatically switched to the **Custom**.

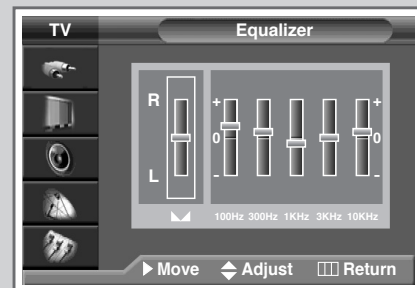
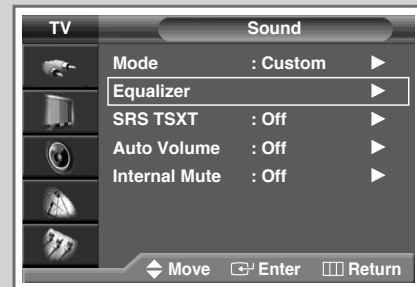

Setting the SRS TSXT

TruSurround XT is a patented SRS technology that solves the problem of playing 5.1 multichannel content over two speakers. TruSurround delivers a compelling, virtual surround sound experience through any two-speaker playback system, including internal television speakers. It is fully compatible with all multichannel formats.

- 1 Press the **MENU** button.
Result: The main menu is displayed.
- 2 Press the **▲** or **▼** button until the **Sound** is selected.
Result: The options available in the **Sound** group are displayed.
- 3 Press the **ENTER** button.
- 4 Press the **▲** or **▼** button until the **SRS TSXT** is selected.
Press the **ENTER** button.
- 5 Select **Off**, **3D Mono** or **Stereo** by pressing the **▲** or **▼** button.
Press the **ENTER** button.

- TruSurround XT, SRS and ((●)) symbol are trademarks of SRS Labs, Inc. TruSurround XT technology is incorporated under license from SRS Labs, Inc.



- You can also set these options simply by pressing the **SRS ((●))** button.

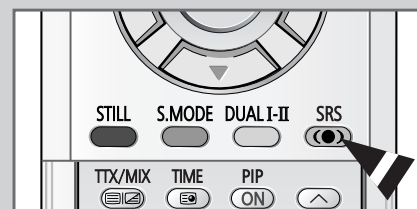

Adjusting the Volume Automatically

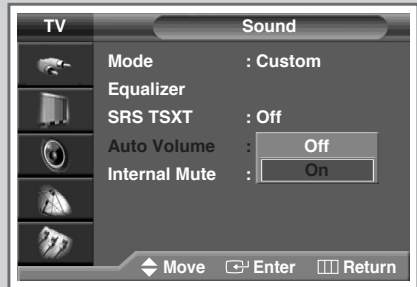



Each broadcasting station has its own signal conditions, and so it is not easy for you to adjust the volume every time the channel is changed. This feature lets you automatically adjust the volume of the desired channel by decreasing the sound output when the modulation signal is high or by increasing the sound output when the modulation signal is decrease.

- 1 Press the **MENU** button.
Result: The main menu is displayed.
- 2 Press the **▲** or **▼** button to select **Sound**.
Result: The options available in the **Sound** group are displayed.
- 3 Press the **ENTER** button.
- 4 Press the **▲** or **▼** button to select **Auto Volume**.
Press the **ENTER** button.
- 5 Select **Off** or **On** by pressing the **▲** or **▼** button. Press the **ENTER** button.

Enjoying the Sound of External Speakers

When using a device such as Home Theater or Amplifier with external speakers, you can set "Internal Mute" to "On" to cutoff sound from the TV's internal speakers.

- 1 Press the **MENU** button.
Result: The main menu is displayed.
- 2 Press the **▲** or **▼** button until the **Sound** is selected.
Result: The options available in the **Sound** group are displayed.
- 3 Press the **ENTER** button.
- 4 Press the **▲** or **▼** button until the **Internal Mute** is selected.
Press the **ENTER** button.
- 5 Select **off** or **On** by pressing the **▲** or **▼** button.
- 6 Press the **ENTER** button to confirm.

➤ The  or **MUTE** button doesn't operate when the **Internal Mute** is set to **On**. At this time, if you press the  or **MUTE** button, the message **Not Available** is displayed.

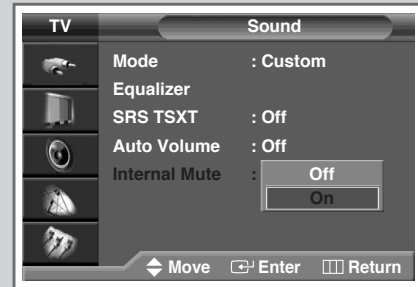

Selecting the Sound Mode (depending on the model)

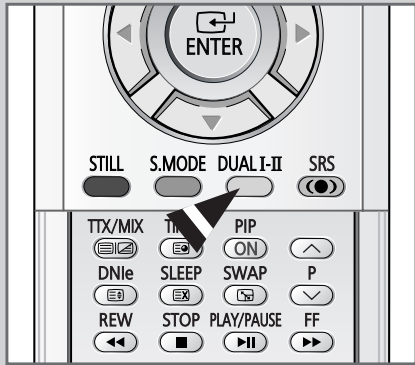

The "DUAL I-II" button displays/controls the processing and output of the audio signal. When power is switched on, the mode is automatically preset to either "Dual I" or "Stereo", depending on the current transmission.

	Type of broadcast	On-screen indication
NICAM Stereo	Regular broadcast (Standard audio)	Mono (Normal use)
	Regular + NICAM Mono	NICAM Mono ↔ Mono
	NICAM Stereo	NICAM Stereo ↔ Mono (Forced mono)
	NICAM Dual 1/2	NICAM Dual 1 → NICAM Dual 2 → Mono
A2 Stereo	Regular broadcast (Standard audio)	Mono
	Bilingual or Dual I/II	Dual I ↔ Dual II
	Stereo	Stereo ↔ Mono (Forced mono)

- ◆ If the receiving conditions deteriorate, listening will be easier if the mode is set to the **Mono**.
- ◆ If the stereo signal is weak and an automatic switching occurs, then switch to the **Mono**.
- ◆ When receiving a mono sound in the AV mode, connect to the "AUDIO-L" input connector on the side of the television. If the mono sound comes out only from left speaker, press the **DUAL I-II** button.

Setting and Displaying the Current Time

You can set the television's clock so that the current time is displayed by pressing the "INFO" button. You must also set the time if you wish to use the automatic on or off timers.

- When pressing the power switch toward "OFF" (O) on the rear of the television, the clock setting will be reset.

- 1 Press the **MENU** button.
Result: The main menu is displayed.
- 2 Press the ▲ or ▼ button to select **Setup**.
Result: The options available in the **Setup** group are displayed.
- 3 Press the **ENTER** button.
- 4 Press the ▲ or ▼ button to select **Time**. Press the **ENTER** button.
Result: The options available in the **Time** group are displayed with **Clock Set** is selected.
- 5 Press the **ENTER** button again.
Result: The **Clock Set** menu is displayed.
- 6 Press the ◀ or ▶ button to move to the **Hour** or **Minute**. Set the current time by pressing the ▲ or ▼ button.
- 7 When you have finished, press the **EXIT** button to exit.
- 8 Press the **INFO** button to display the current time.

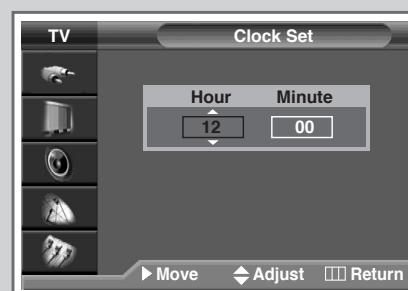
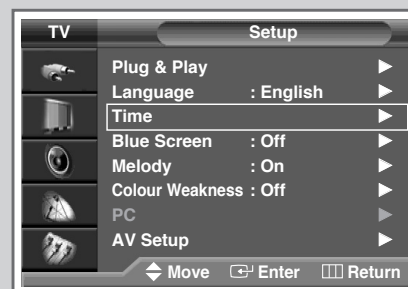

Setting the Sleep Timer

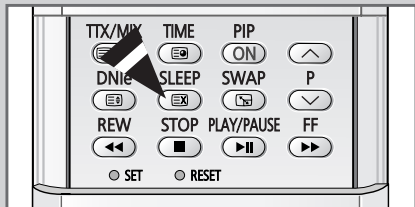
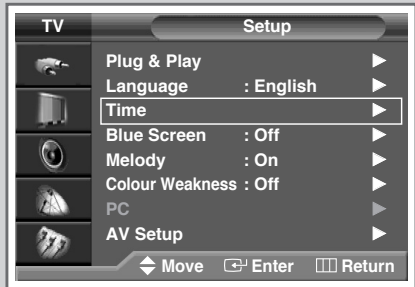

You can select a time period of between 30 and 180 minutes after which the television automatically switches to standby mode.

- 1 Press the **MENU** button.
Result: The main menu is displayed.
- 2 Press the **▲** or **▼** button to select **Setup**.
Result: The options available in the **Setup** group are displayed.
- 3 Press the **ENTER** button.
- 4 Press the **▲** or **▼** button to select **Time**. Press the **ENTER** button.
Result: The options available in the **Time** group are displayed.
- 5 Press the **▲** or **▼** button to select **Sleep Timer**. Press the **ENTER** button.
- 6 Select the preset time intervals (**Off**, **30**, **60**, **90**, **120**, **150**, **180**) by pressing the **▲** or **▼** button.
- 7 Press the **ENTER** button to confirm.

- You can also set these options simply by pressing the **SLEEP** button.
- ◆ If the sleep timer is not yet set, **Off** is displayed. If the sleep timer is already set, the remaining time before which the television switches to standby mode is displayed.
- Your TV automatically turns off when it receives no input signal for 15 minutes or longer.

Switching the Television On and Off Automatically

You can set the On or Off timers so that the television will:

- ◆ Switch on automatically and tune to the channel of your choice at the time you select
 - ◆ Switch off automatically at the time you select
- The first step is to set the television's clock (refer to "Setting and Displaying the Current Time" on page 39). If you have not yet set the clock, the message **Set the clock first** is displayed.

- 1 Press the **MENU** button.
Result: The main menu is displayed.
- 2 Press the **▲** or **▼** button to select **Setup**.
Result: The options available in the **Setup** group are displayed.
- 3 Press the **ENTER** button.
- 4 Press the **▲** or **▼** button to select **Time**. Press the **ENTER** button.
Result: The options available in the **Time** group are displayed.
- 5 Press the **▲** or **▼** button to select **On Timer**. Press the **ENTER** button.
Result: The options available in the **On Timer** group are displayed.
- 6 Select the **Hour**, **Minute**, **Prog.** (programme number) or **Volume** by pressing the **◀** or **▶** button. Set these by pressing the **▲** or **▼** button.
- 7 To activate the On Timer with the settings satisfied, select **Activation** by pressing the **◀** or **▶** button, then select **Yes** by pressing the **▲** or **▼** button.
- 8 Press the **MENU** button.
Result: The options available in the **Time** group are displayed again.
- 9 Press the **▲** or **▼** button to select **Off Timer**. Press the **ENTER** button.
Result: The options available in the **Off Timer** group are displayed.
- 10 Set the **off Timer** as methods for **On Timer** setting.

➤ Auto Power Off

Auto Power OFF will automatically turn the TV off if you do not operate any controls within 3 hours after the TV is turned on by the timer. This function is available in the timer "On" mode only and will prevent a leakage accident or overheating caused by your TV being left on too long.

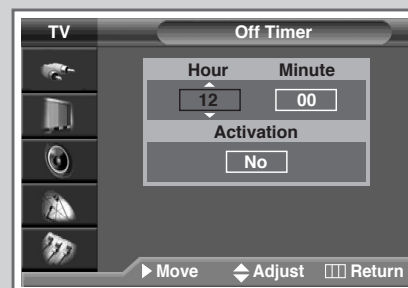

Setting the Blue Screen



If no signal is being received or the signal is very weak, a blue screen automatically replaces the noisy picture background. If you wish to continue viewing the poor picture, you must set the "Blue Screen" mode to "Off".

- 1 Press the **MENU** button.
Result: The main menu is displayed.
- 2 Press the **▲** or **▼** button to select **Setup**.
Result: The options available in the **Setup** group are displayed.
- 3 Press the **ENTER** button.
- 4 Press the **▲** or **▼** button to select **Blue Screen**. Press the **ENTER** button.
- 5 Select **Off** or **On** by pressing the **▲** or **▼** button.
- 6 Press the **ENTER** button.

Setting the Melody Sound



You can hear melody sound when the television is powered on or off.

- 1 Press the **MENU** button.
Result: The main menu is displayed.
- 2 Press the **▲** or **▼** button to select **Setup**.
Result: The options available in the **Setup** group are displayed.
- 3 Press the **ENTER** button.
- 4 Press the **▲** or **▼** button to select **Melody**. Press the **ENTER** button.
- 5 Select **Off** or **On** by pressing the **▲** or **▼** button.
- 6 Press the **ENTER** button.

Using the Colour Weakness Enhancement Feature

This feature adjusts the Red, Green or Blue colour to enhance the picture according to the user's particular colour weakness.

- 1 Press the **MENU** button.
Result: The main menu is displayed.
- 2 Press the **▲** or **▼** button to select **Setup**.
Result: The options available in the **Setup** group are displayed.
- 3 Press the **ENTER** button.
- 4 Press the **▲** or **▼** button to select **Colour Weakness**.
Press the **ENTER** button.
Result: The options available in the **Colour Weakness** group are displayed.
- 5 Press the **ENTER** button again.
Press the **▲** or **▼** button to select **On**, then press the **ENTER** button.
- 6 Press the **▲** or **▼** button to select the colour you wish to adjust, then press the **ENTER** button.
- 7 Press the **◀** or **▶** button to adjust to your preference.
- 8 Press the **MENU** or **ENTER** button to confirm.

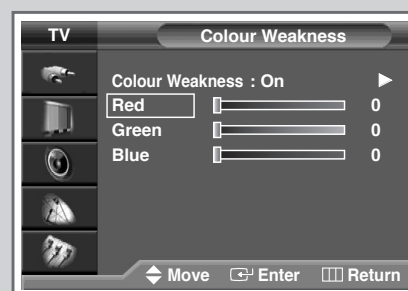
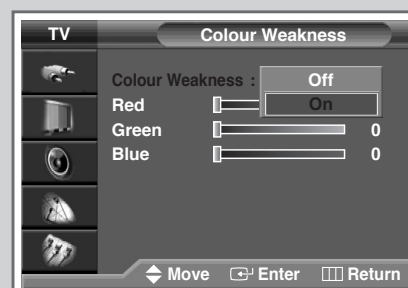
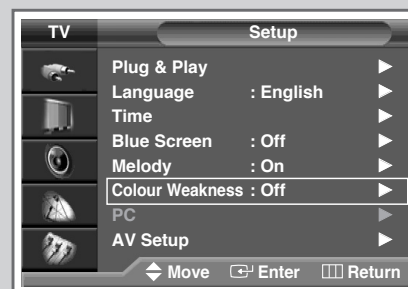

Setting the Picture in PC Mode

➤ Preset to the PC mode by using the **SOURCE** button.

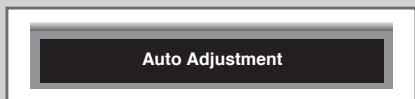
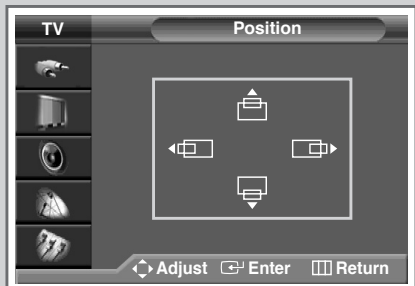
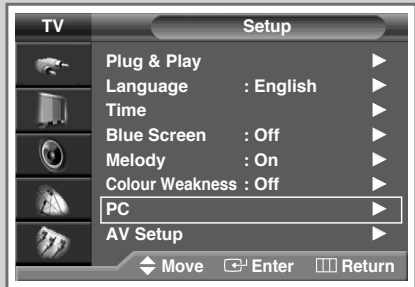

- 1 Press the **MENU** button.
Result: The main menu is displayed.
- 2 Press the **▲** or **▼** button to select **Setup**.
Result: The options available in the **Setup** group are displayed.
- 3 Press the **ENTER** button.
- 4 Press the **▲** or **▼** button to select **PC**. Press the **ENTER** button.
Result: The options available in the **PC** group are displayed.
- 5 Select **Coarse** or **Fine** by pressing the **▲** or **▼** button.
Press the **ENTER** button.
- 6 Press the **◀** or **▶** button until you reach the required setting.
Press the **ENTER** button.
Result: The **PC** menu is displayed again.
- 7 Press the **▲** or **▼** button to select **Position**.
Press the **ENTER** button.
Set to the required position by pressing the **▲/▼/◀/▶** button.
Press the **ENTER** button.
- 8 To adjust the screen quality and position automatically, select the **Auto Adjustment** by pressing the **▲** or **▼** button.
Result: The **Auto Adjustment** is displayed. The screen quality and position are automatically adjusted.
- 9 Press the **ENTER** button.

Viewing an External Signal Source

Use the remote control to switch between viewing signals from connected equipment, such as VCR, DVD, Set-Top box and the TV source (broadcast or cable).

- 1 Press the **MENU** button.
Result: The main menu is displayed.
- 2 Press the **▲** or **▼** button to select **Input** .
Result: The options available in the **Input** group are displayed.
- 3 Press the **ENTER** button.
Result: The options available in the **Source List** group are displayed.
- 4 Press the **ENTER** button again.
- 5 Press the **▲** or **▼** button to select signal source, then press the **ENTER** button.

➤ You can also set these options simply by pressing the **SOURCE** button. If you change the external source while viewing, pictures might take a short period of time to be switched.



Assigning Names to External Sources



This feature enables you to name the input source you have connected.

- 1 Press the **MENU** button.
Result: The main menu is displayed.
- 2 Press the **▲** or **▼** button to select **Input** .
Result: The options available in the **Input** group are displayed.
- 3 Press the **ENTER** button.
- 4 Press the **▲** or **▼** button to select **Edit Name**.
Press the **ENTER** button.
- 5 Press the **▲** or **▼** button to select the external source to be edited.
Press the **ENTER** button.
Result: The device names available are listed.
**VCR - DVD - Cable STB - HD STB - Satellite STB
- AV Receiver - DVD Receiver - Game -
Camcorder - DVD Combo - DHR (DVD HDD Recorder)
- PC - TV.**
- 6 Select the required device by pressing the **▲** or **▼** button.
- 7 Press the **ENTER** button to confirm.

Teletext Feature

Most television channels provide written information services via teletext. Information provided includes:

- ◆ *Television programme times*
- ◆ *News bulletins and weather forecasts*
- ◆ *Sports results*
- ◆ *Travel information*

This information is divided into numbered pages (see diagram).

Part	Contents
A	Selected page number.
B	Broadcasting channel identity.
C	Current page number or search indications.
D	Date and time.
E	Text.
F	Status information. FASTEXT information.

- Teletext information is often divided between several pages displayed in sequence, which can be accessed by:
- ◆ Entering the page number
 - ◆ Selecting a title in a list
 - ◆ Selecting a coloured heading (FASTEXT system)

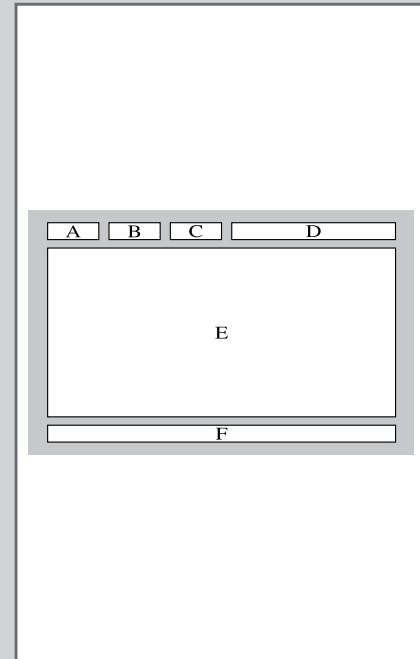



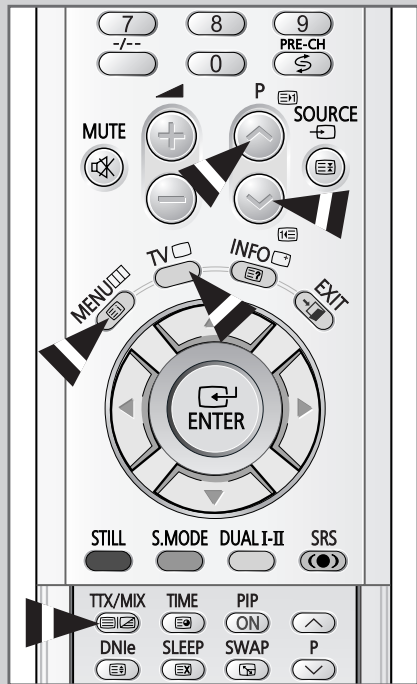

Displaying the Teletext Information



You can display Teletext information at any time on your television.





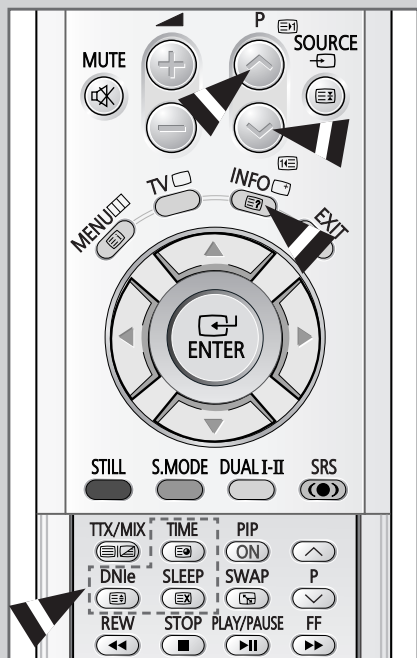

- ☞ For Teletext information to be displayed correctly, channel reception must be stable; otherwise:
 - ◆ Information may be missing
 - ◆ Some pages may not be displayed

- 1 Select the channel providing the Teletext service by pressing the **P** or **P** button.
- 2 Press the **TTX/MIX** () button to activate the teletext mode.
Result: The contents page is displayed. It can be redisplayed at any time by pressing the  (index) button.
- 3 Press the **TTX/MIX** () button again.
Result: The screen will be split into two. This Double Teletext feature lets you view the actual broadcast and teletext information separately on the screen.
- 4 If you wish to display the teletext information on a single screen, press the **TTX/MIX** () button again.
- 5 To exit from the teletext display, press the **TV** () button.

Selecting Display Options



When you have displayed a Teletext page, you can select various options to suit your requirements.

To display...	Press the...
◆ Hidden text (answers to quiz games, for example)	 (reveal)
◆ The normal screen	 (reveal) again
◆ A secondary page by entering its number	 (sub-page)
◆ The broadcast when searching for a page	 (cancel)
◆ The next page	 (page up)
◆ The previous page	 (page down)
◆ Double-size letters in the: <ul style="list-style-type: none"> • Upper half of the screen • Lower half of the screen 	 (size) <ul style="list-style-type: none"> • Once • Twice
◆ The normal screen	<ul style="list-style-type: none"> • Three times



Selecting a Teletext Page

You can enter the page number directly by pressing the numeric buttons on the remote control.

- 1 Enter the three-digit page number given in the content by pressing the corresponding numeric buttons.

Result: The current page counter is incremented and the page is then displayed. If the selected page is linked with several secondary pages, the secondary pages are displayed in sequence. To freeze the display on a given page, press the  (hold) button. Press it again to resume.
- 2 If the FASTEXT system is used by the broadcasting company, the different topics covered on a Teletext page are colour-coded and can be selected by pressing the coloured buttons on the remote control. Press the coloured button corresponding to the topic that you wish to select; the available topics are given on the status line.

Result: The page is displayed with other coloured information that can be selected in the same way.
- 3 To display the previous or next page, press the corresponding coloured button.
- 4 To display the subpage, see the following steps.
 - ◆ Press the  (sub-page) button.

Result: The available subpages appear.
 - ◆ Select the required sub-page. Sub-pages can be scrolled by pressing the  or  button.

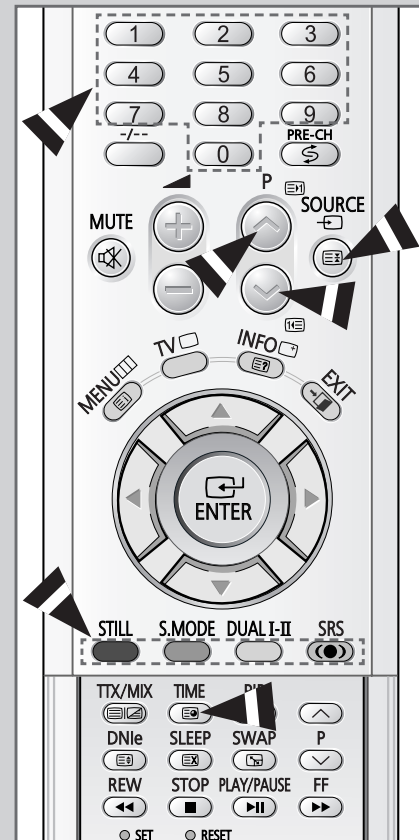

Connecting to the External Input/Output

The “EXT1” and “EXT3” are used for the equipment with an RGB output, such as video game devices or video disc players.

Rear of the TV

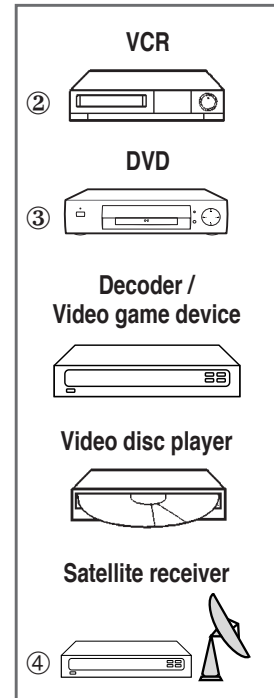
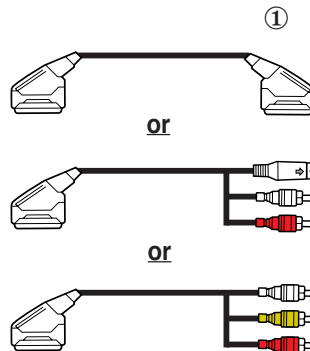
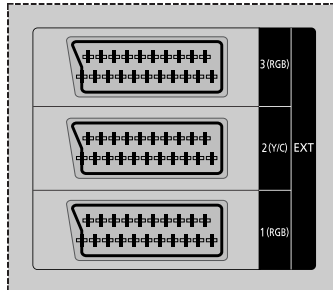

- ① This end can be fitted with:
 - ◆ A SCART connector
 - ◆ An S-Video connector and two audio RCA connectors (L+R); **EXT 2**
 - ◆ Three RCA connectors (VIDEO + AUDIO-L and R)
- ② If you have a second VCR and wish to copy cassette tape, connect the source VCR to **EXT1** (or **EXT3**) and the target VCR to **EXT2** so that you can redirect the signal from **EXT1** (or **EXT3**) to **EXT2**.
- ③ If you have a decoder, connect the decoder to the VCR and the VCR to the television.
- ④ When you wish to record a programme, connect the receiver to **EXT1** (or **EXT3**) and the VCR to **EXT2** so that you can redirect the signal from **EXT1** (or **EXT3**) to **EXT2**.



Whenever you connect an audio or video system to your television, ensure that all elements are switched off.

Refer to the documentation supplied with your equipment for detailed connection instructions and associated safety precautions.

Connecting to the Audio Output

- The RCA (**AUDIO OUT-L** and **R**) connectors are used for equipment, such as an audio system.

Rear of the TV

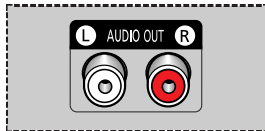

Audio system

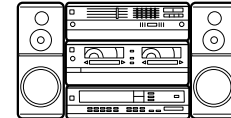

Connecting to the S-Video Input

- The “**S-VIDEO**” and “**AUDIO-L/R**” connectors are used for equipment with an S-Video output, such as a camcorder or VCR.

Rear of the TV

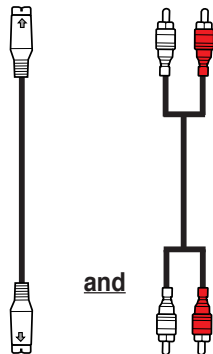

Camcorder

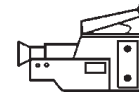

VCR

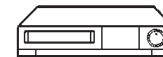

- To play picture and sound, both the **S-VIDEO** and **AUDIO-L/R** connectors must be used.

Connecting to the Digital Input

The “HDMI/DVI IN” and “AUDIO-L/R” connectors are used for equipment with a digital output. By inputting a high-bandwidth digital content protection high-definition picture source to these jacks, high-definition pictures can be displayed on the screen in their digital forms.

Rear of the TV

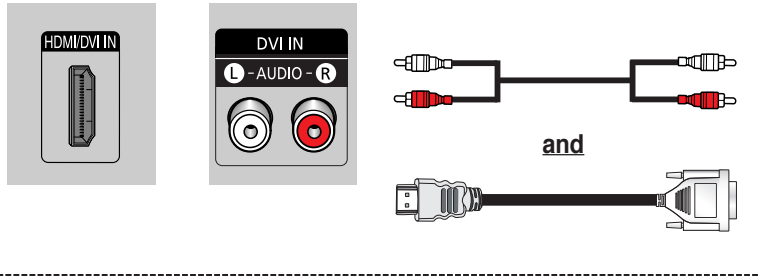

or

Rear of the TV

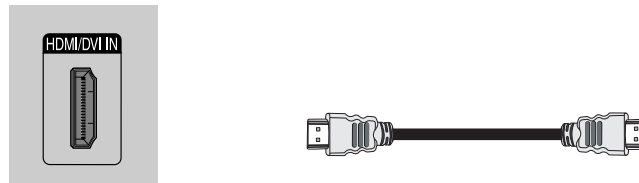

Personal Computer



DVD

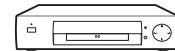

DTV receiver

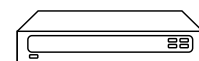

➤ The “HDMI/DVI IN” does not support the Analog R (red), G (green) and B (blue) signals.



Please check if the HDMI source's power is on, in case that you fail to select HDMI from the “Source List” even after you connected the cable of the HDMI source (DTV Set-Top Box, DVD, etc.) to TV.

Connecting to the Component Input

Rear of the TV

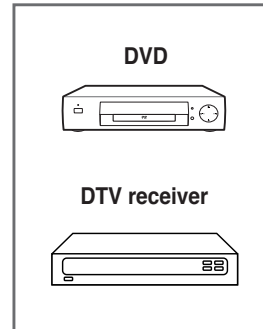
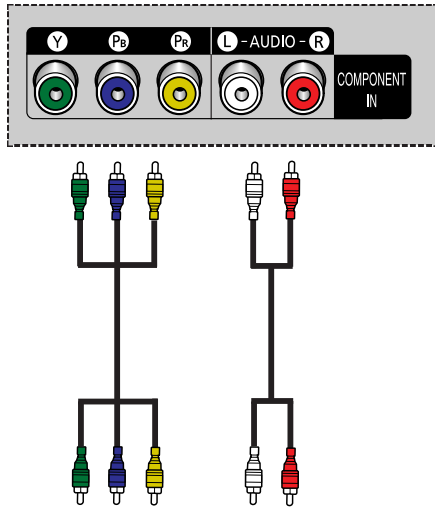

- The **COMPONENT IN** connectors are used for equipment with a DVD or DTV receiver output. (480i, 480p, 576i, 576p, 720p, 1080i)

Connecting to the PC Input

The “PC” (video) and “AUDIO-L/R” connectors are used for interfacing with your PC.

Rear of the TV

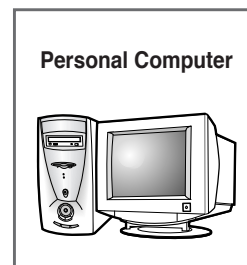
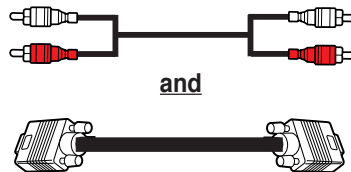
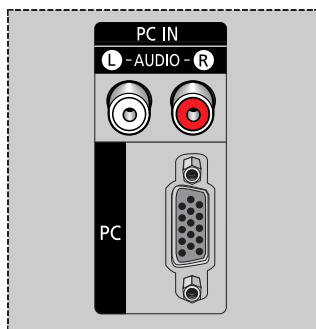

Setting up Your PC Software (Windows only)

The Windows display-settings for a typical computer are shown below. But the actual screens on your PC will probably be different, depending upon your particular version of Windows and your particular video card. But even if your actual screens look different, the same, basic set-up information will apply in almost all cases. (If not, contact your computer manufacturer or Samsung Dealer.)



1 Right click the mouse on the Windows Desktop, then click on Properties. The **Display Dialog-Box** will be displayed.

2 Click on **Settings**, then set the **Display Mode** with reference to the Display Modes Table. You do not need to change the **Colours** settings.

3 Click on **Advanced**. A new settings dialog box will be displayed.

4 Click on the **Monitor** tab, then set the **Screen Refresh Rate** with reference to the Display Modes Table. Set the **Vertical Frequency** and **Horizontal Frequency** individually if you can do so instead of setting the **Screen Refresh Rate**.

5 Press the **OK** button, close the window, then press the **OK** button on the **Display Registration Information** window. Automatic re-booting may commence at this moment.

6 Shutdown the PC, and connect it to your TV. (See page 53)

- ◆ The actual screens on your PC may look different, depending on your particular version of Windows and the type of your PC.
- ◆ When you use your TV as a PC monitor, it supports Colours up to 32 bits.
- ◆ In this case, the display on the TV may look different depending on your particular version of Windows or the PC manufacturer.
- ◆ When connecting a PC (including the DVI connection), you must set it to the display settings that are supported by the TV. Otherwise, the message **Out of input range** will be displayed.

PC/HDMI(DVI) Input Mode

Both screen position and size will vary depending on the type of PC monitor and its resolution. The table below shows all of the display modes that are supported:

Standard	Resolution	Horizontal frequency (kHz)	Vertical frequency (Hz)	Pixel Clock (MHz)	Sync Polarity (H/V)
VGA	720 x 400	31.47	70.00	28.322	-/-
	640 x 480	31.47	60.00	25.175	-/+
		35.00	66.70	30.24	-/-
		37.86	72.80	31.50	-/-
		37.50	75.00	31.50	-/-
		43.27	85.00	36.00	-/-
SVGA	800 x 600	35.16	56.30	36.00	-+/-
		37.88	60.30	40.00	+/+
		48.08	72.20	50.00	+/+
		46.87	75.00	49.50	+/+
		53.67	85.10	56.25	+/+
	832 x 624	49.73	74.60	57.284	-/+
	XGA	1024 x 768	48.36	60.00	65.00
56.40			70.10	75.00	-/-
60.02			75.00	78.75	+/-
DTV (EIA/CEA-861-B)	720 x 576	31.25	50.00	27.00	X
	720 x 480	31.50	60.00	27.027	X
	1280 x 720p	37.50	50.00	74.25	X
		45.00	60.00	74.25	X
	1920 x 1080i	28.125	50.00	74.25	X
33.75		60.00	74.25	X	

- ◆ The interlace mode is not supported.
- ◆ The television might operate abnormally if a non-standard video format is selected.
- ◆ The 4:3 mode does not work with input signals from "720 x 400".
- ◆ 640*480 PC signal is basically recognized as 720*480 TV signal in PC/HDMI mode. Select 'PC' in Edit Name to recognize the signal as 640*480 PC signal. Refer to Assigning Names to External Sources on page 46.

Notes

- ◆ **The text quality of PC screen is optimum in the XGA mode (1024 x 768), the full size displayed PC mode is optimum in the SVGA mode (800 x 600).**
- ◆ When this television is used as a PC display, 24-bit colour is supported (over 16 million colours).
- ◆ Your PC display screen might appear different depending on the manufacturer (and your particular version of Windows). Check your PC instruction book for information about connecting your PC to a television.
- ◆ If a vertical and horizontal frequency-select mode exists, select 60Hz (vertical) and 31.5kHz (horizontal). In some cases, abnormal signals (such as stripes) might appear on the screen when the PC power is turned off (or if the PC is disconnected). If so, press the **SOURCE** button to enter the Video mode. Also, make sure that the PC is connected.
- ◆ When connecting a notebook PC to the television, make sure that the PC screen is displayed through only the television (Otherwise, random signals might appear).
- ◆ When horizontal synchronous signals seem irregular in PC mode, check PC power saving mode or cable connections.

Redirecting an Input to the External Output

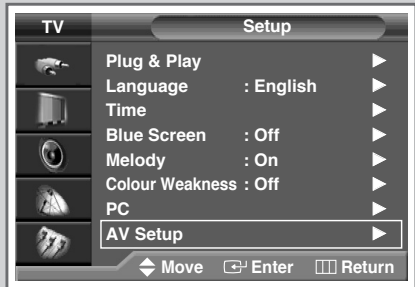

Your television enables you to choose which audio/video signals are output to the external connector.

- 1 Press the **MENU** button.
Result: The main menu is displayed.
- 2 Press the **▲** or **▼** button to select **Setup**.
Result: The options available in the **Setup** group are displayed.
- 3 Press the **ENTER** button.
- 4 Press the **▲** or **▼** button until the **AV Setup** is selected. Press the **ENTER** button.
Result: The **AV Setup** menu is displayed.
- 5 Select the output connector required (**Ext.2** or **Ext.3**) by pressing the **▲** or **▼** button. Press the **ENTER** button.
- 6 Select the source to be directed to the output connector selected by pressing the **▲** or **▼** button.
 - **Ext.1** : Default (**TV**)
Ext.2 : Variable (**TV, Ext.1 Video, Ext.1 S-Video, Ext.3 Video, Ext.3 S-Video, AV or S-Video**)
 - Ext.3** : Variable (**TV, Ext.1 Video, Ext.1 S-Video, Ext.2 Video, Ext.2 S-Video, AV or S-Video**)
- 7 Press the **ENTER** button to confirm your choice.

Setting Up Your Remote Control

This TV's remote control can operate VCR, CATV, DVD, or Set-top box (STB), in addition to controlling the TV.

- *The remote control might not be compatible with all DVD Players, VCRs and Cable boxes.*

- 1 Turn off your VCR, Cable box, DVD or STB.
- 2 Press the **SELECT** button. Mode is changed whenever **SELECT** button is pressed.
- 3 Press the **POWER** (⏻) button on the remote control. The component you select should turn on. If it turns on, your remote control is now set correctly.
- 4 Once your remote control is set up, press the **SELECT** button any time you want to use the remote control to operate your VCR, Cable box, DVD or STB.

- When your remote control is in the **VCR, CATV, DVD** or **STB** mode, the volume buttons still control your television's volume.

- To program the cable receiver controls:
- ◆ Press the **SELECT** button to select **CATV**.
 - ◆ Point the remote control at the cable receiver and press the **SET** button. Then press the company code number(s) for the component in page 59.
Ex) If the component is manufactured by Oak, press 026.
- To program the **VCR** controls:
- ◆ Press the **SELECT** button to select **VCR**
 - ◆ Point the remote control at the **VCR** and press the **SET** button. Then press the company code number(s) for the component in page 58 or 59.
- To program the **DVD** controls:
- ◆ Press the **SELECT** button to select **DVD**
 - ◆ Point the remote control at the **DVD** and press the **SET** button. Then press the company code number(s) for the component in page 59.

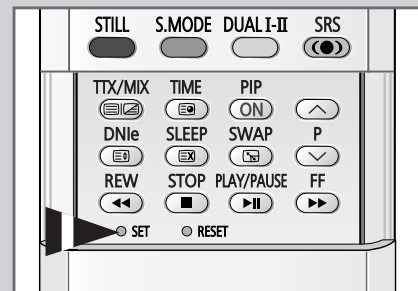
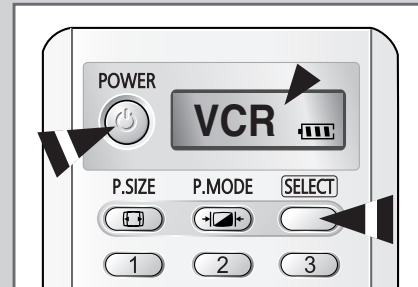

Programming the Remote Control for Other Components

VCR Remote Control Codes

Admiral	020	Marantz	007, 008, 018, 021, 026, 036, 037, 062
Aiwa	025	Marta	006
Akai	004, 027, 032	MEI	021
Audio Dynamics	007, 026	Memorex	006, 021, 024, 025
Bell&Howell	018	MGA	034
Broksonic	022	Midland	005
Candle	002, 003, 006, 008, 015, 055	Minolta	019, 041
Canon	021, 056	Mitsubishi	019, 034, 041, 046
Citizen	002, 003, 006, 008, 015, 055	Montgomery Ward	020
Colortyme	007	MTC	002, 025
Craig	002, 024	Multitech	002, 005, 025, 038
Curtis Mathes	002, 007, 008, 017, 021, 025, 056, 064, 066	NEC	007, 008, 018, 026, 037, 062, 064
		Optimus	020
Daewoo	003, 010, 011, 012, 013, 014, 015, 016	Panasonic	021, 056, 071, 072
DBX	007, 026	Pentax	019, 041
Dimensia	017	Pentex Research	008
Dynatech	034	Philco	021, 036, 056, 059
		Philips	021, 036
		Pioneer	019, 026, 039, 053
Emerson	001, 003, 006, 021, 022, 025, 030, 032, 034, 040, 047, 050, 052, 060, 063, 065, 066, 067, 069	Portland	015, 049, 055
		PROSCAN	017
Fisher	018, 024, 028, 029, 048, 051, 061	Quartz	018
Funai	025	Quasar	021, 056
General Electric	002, 005, 017, 021, 056	Radio Shack/Realistic	006, 018, 020, 021, 024, 025, 029, 034, 048, 056
Go Video	002		
LG (Goldstar)	006, 007, 008, 009, 010	RCA	002, 017, 019, 021, 035, 041, 043, 057, 068
Harman Kardon	007		
Hitachi	019, 025, 041, 042	Samsung	000, 001, 002, 003, 004, 005
Instant Replay	021	Sansui	026
JC Penney	002, 007, 018, 019, 021, 026, 037, 041, 054, 056	Sanyo	018, 024
		Scott	003, 047, 052, 067
JVC	007, 008, 018, 021, 026, 037	Sears	006, 018, 019, 024, 028, 029, 041, 048, 051
Kenwood	007, 008, 018, 026, 037		
KLH	070	Sharp	020, 034, 045, 015
Lloyd	025	Shimom	027, 033, 038, 058
Logik	038	Signature	025
LXI	025	Sony	027, 033, 044
Magnavox	021, 036, 056, 059		

Programming the Remote Control for Other Components

VCR Remote Control Codes (continued)

Sylvania	021, 025, 036, 056, 059	Totevision	002, 006
Symphonic	025	Unitech	002
Tandy	018, 025	Vector Research	007, 026
Tashika	006	Victor	026
Tatung	037	Video Concepts	007, 026
Teac	025, 037, 068	Videosonic	002
Technics	021	Wards	002, 003, 006, 019, 020, 021, 024, 025, 034, 038, 041
Teknika	006, 021, 025, 031		
TMK	066	Yamaha	007, 008, 018, 026, 037
Toshiba	003, 019, 029, 051, 052	Zenith	023, 027, 033, 073

Cable Box (CATV) Remote Control Codes

Anvision	017, 018	Regency	015, 023
GI	041	SA	042, 043
Hamlin	003, 024, 031	Samsung	000, 001, 002, 003, 004, 005, 006, 007
Hitachi	025, 030	Scientific Atlanta	042, 043
Jerrold	038, 039	Sprucer	022
Macom	025, 030	Stargate 2000	036
Magnavox	019, 023, 028	Sylvania	016
Oak	026	Texscan	016
Panasonic	003, 022, 027, 037, 044	Tocom	032
Philips	019, 021, 023, 028	Universal	033, 034
Pioneer	004, 018, 020, 044	Viewstar	019, 021, 023, 028
RCA	014, 022, 040	Wamer amex	046
Regal	003	Zenith	017, 029, 035, 037, 045

DVD Remote Control Codes

Samsung	000, 001	LG (Goldstar)	006
JVC	002	Sony	007
PROSCAN/RCA	003	Denon	008
Panasonic	005	Curtis Mathes	009

Replacing the Lamp

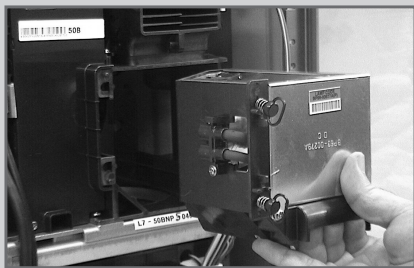
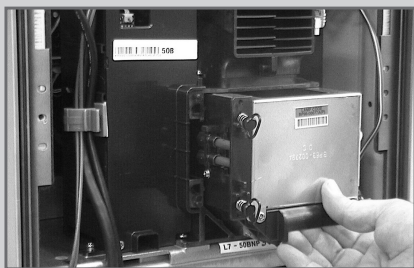
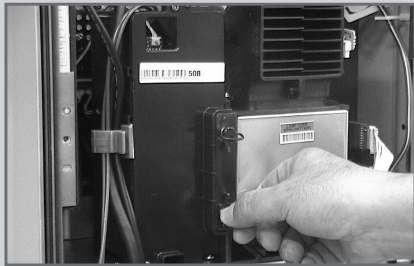
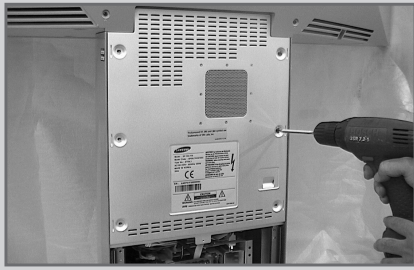

- 1 Unplug TV, then use a screwdriver to remove the screw.
- 2 Remove the Lamp cover.
- 3 Remove the screws securing the Lamp by using a screwdriver.
- 4 Separate the Lamp from the engine by holding the handle and pulling it out
- 5 To reinstall the Lamp, follow these steps in reverse order.

- ◆ Why do I need to replace the lamp?
The lamp used in a projection TV has a limited lifespan. For the best screen quality it needs to be replaced periodically. After replacing the lamp, the screen quality will be bright and clear as new.
- ◆ When do I need to replace it?
It should be replaced when the screen becomes darker, less clear or when all three LEDs on the front (TIMER, LAMP and STAND BY/TEMP) are flashing.
- ◆ Check before lamp replacement
 - Turn the power off and wait for 30 minutes before replacing the lamp as it will be hot.
 - The lamp must be the same code to avoid damage to the TV. The lamp code is indicated on the lamp case or the side of TV.
 - After checking the lamp code, give to the store where you purchased the TV or to a Samsung Service Center.
- ◆ Caution
 - Do not touch the glass part of the lamp with your bare hands nor insert any foreign object inside the cover as it may cause poor screen quality, electric shock or fire.
 - Do not place the old lamp near flammable objects or within the reach of children.
 - Don't allow dirt or dust to accumulate inside the lamp cover or on the lamp. A dirty cover or lamp can catch fire, explode and cause electric shock.
 - If a new lamp is improperly handled, the screen quality can be affected and the expected lifespan of the lamp can be reduced.
 - Be sure to tighten the lamp cover on the TV after changing the lamp. Note that the TV will not function if the lamp cover is not securely attached. Please tighten the holding screw on the lamp cover after it has been attached to the TV.

Troubleshooting: Before Contacting Service Personnel

Before contacting Samsung after-sales service, perform the following simple checks.

If you cannot solve the problem using the instructions below, note the model and serial number of the television and contact your local dealer.

No sound or picture	<ul style="list-style-type: none">◆ Check that the mains lead has been connected to a wall socket.◆ Check that you have pressed the power switch toward "OFF" (O) or the POWER (⊕) button on the remote control or the front of the television.◆ Check the picture contrast and brightness settings.◆ Check the volume.
Normal picture but no sound	<ul style="list-style-type: none">◆ Check the volume.◆ Check whether the volume MUTE button on the remote control has been pressed.◆ Check that the Internal Mute is set to On.
No picture or black and white picture	<ul style="list-style-type: none">◆ Adjust the colour settings.◆ Check that the broadcast system selected is correct.
Sound and picture interference	<ul style="list-style-type: none">◆ Try to identify the electrical appliance that is affecting the television, then move it further away.◆ Plug your television into a different mains socket.
Blurred or snowy picture, distorted sound	<ul style="list-style-type: none">◆ Check the direction, location and connections of your aerial. This interference often occurs due to the use of an indoor aerial.
Remote control malfunctions	<ul style="list-style-type: none">◆ Replace the remote control batteries.◆ Clean the upper edge of the remote control (transmission window).◆ Check the battery terminals.

Technical Specifications

The descriptions and characteristics in this booklet are given for information purposes only and are subject to modification without notice.

Model name	SP50L7HX	SP56L7HX
Colour systems	PAL, SECAM, NTSC4.43	
TV standards	BG, DK, I, L, L'	
Audio output power	15 W + 15 W	
Dimensions (W x D x H)	1361 x 520 x 1388 mm	1491 x 556 x 1482 mm
Weight	56.7 kg	61 kg

Memo

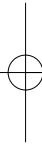
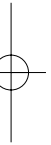

– AFTER SALES SERVICE

- Do not hesitate to contact your retailer or service agent if a change in the performance of your product indicates that a faulty condition may be present.

